

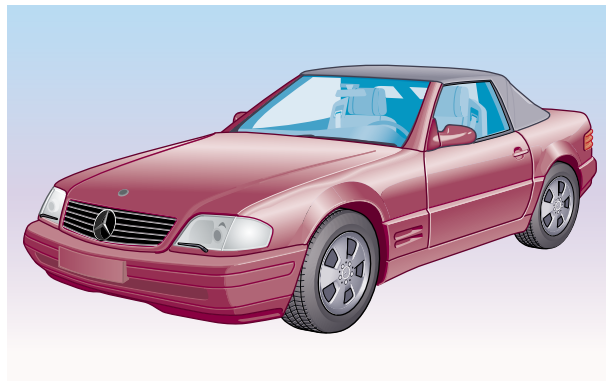

Mercedes-Benz



SL Operator's Manual

SL 500

SL 600

Our company and staff congratulate you on the purchase of your new Mercedes-Benz.

Your selection of our product is a demonstration of your trust in our company name. Further, it exemplifies your desire to own an automobile that will be as easy as possible to operate and provide years of service.

Your Mercedes-Benz represents the efforts of many skilled engineers and craftsmen. To ensure your pleasure of ownership, and for your safety and that of your passengers, we ask you to make a small investment of your time:

- Please read this manual carefully before putting it aside. Then return it to your vehicle where it will be handy for your reference.
- Please abide by the recommendations contained in this manual. They are designed to acquaint you with the operation of your Mercedes-Benz.
- Please abide by the warnings and cautions contained in this manual. They are designed to help improve the safety of the vehicle operator and occupants.

We extend our best wishes for many miles of safe, pleasurable driving.

DaimlerChrysler AG

Introduction

Product information	7
Operator's manual	8
Where to find it	13
Problems with your vehicle	14
Reporting Safety Defects	15

Instruments and controls

Instruments and controls	18
Door control panel	20
Overhead control panel	21
Dashboard	22
Center console	24

Operation

Vehicle keys	28
Remote control with folding master key	28
Central locking system	30
Remote control	30
Locking and unlocking	31

Choosing global or selective mode on remote control	32
Opening the trunk	32
Panic button	33
Start lock-out	34
General notes on the central locking system	34
Doors	35
Central locking switch	37
Automatic central locking	38
Emergency unlocking in case of accident	39
Trunk	39
Trunk lid release switch	40
Power windows	41
Antitheft alarm system	42
Tow-away alarm	43
Power seats	44
Storing position in memory	46
Backrest	48
Multicontour seats	49
Seat heater	50
Seat belts and integrated restraint system	52

Seat belts	52
Seat belt nonusage warning system	53
Fastening of seat belts	54
BabySmart™ airbag deactivation system	58
Self-test BabySmart™ without special child seat installed	59
Supplemental restraint system (SRS)	59
Emergency tensioning retractor (ETR)	60
Airbags	60
Front airbags	62
Side impact airbags	63
Safety guidelines for the seat belt, emergency tensioning retractor and airbag	66
Infant and child restraint systems	67
Adjusting steering column	70
Storing steering column position in memory	70
Rear view mirrors	71
Inside rear view mirror	71

Antiglare night position	71	Engine oil level indicator in odometer display field	82	Audio and telephone, operation	98
Exterior rear view mirrors	72	Fuel consumption gauge	83	Power windows	116
Storing mirror positions in memory	73	Engine oil temperature gauge	83	Express opening of door windows	117
Instrument cluster	74	Engine oil consumption	83	Synchronizing power windows	117
Indicator lamps in the instrument cluster	76	Exterior lamp switch	84	Roll bar	118
Additional function indicator lamps	77	Standing lamps	85	Interior lighting	120
Instrument lamps	77	Night security illumination	85	Interior lamps	120
Display illumination	77	Combination switch	86	Reading lamps	120
Coolant temperature gauge	78	Blocked windshield wiper	88	Entrance lamps in footwells, exit lamps in doors	120
Outside temperature indicator	78	Windshield wiper smears	88	Sunshade, manual	121
Trip odometer	79	Windshield and headlamp washer fluid mixing ratio	88	Power sunshade	122
Clock	79	Hazard warning flasher switch	89	Sun visors	123
Tachometer	79	Automatic climate control	90	Illuminated vanity mirror	123
Flexible service system (FSS)	80	Display and controls	92	Interior	124
		Basic setting - automatic mode .	93		
		Economy	93		
		Special settings	94		

Storage compartment (eyeglasses compartment) in the dashboard	124	Soft top	143	Turning off	167
Interior central locking system	125	Lowering soft top	144	Automatic transmission	168
Integration with vehicle central locking system	126	Raising soft top	145	Driving	168
Separate locking of storage compartments	126	Wind screen	148	Accelerator Position	169
Armrest	127	Antenna	151	Selector lever positions	169
Console storage compartments	127	Driving		Maneuvering	172
Cup holder	128	Control and operation of radio transmitters	153	Stopping	172
Parcel net in passenger footwell	128	Radio, telephone and two-way radio	153	Program mode selector switch	173
Door pockets	129	Telephones and two-way radio	153	Emergency Operation	174
Rear storage compartment	129	The first 1 000 miles (1 500 km)	154	Parking brake	175
Ashtray with lighter	130	Maintenance	154	Driving instructions	176
Lighter	131	Tele Aid	155	Drive sensibly - Save fuel	176
Telephone, general	132	Catalytic converter	163	Drinking and driving	176
Garage door opener	133	Emission control	164	Pedals	176
Hardtop or panorama roof	137	Steering lock	165	Power assistance	177
Removing hardtop	137	Starting and turning off the engine	167	Brakes	177
Attaching hardtop	140	Before starting	167	Driving off	178
		Starting	167	Parking	178
				Tires	179
				Aquaplaning	180
				Tire traction	180
				Tire speed rating	181
				Snow chains	181

Vehicles with sport package	181
Winter driving instructions	182
Winter driving	183
Block heater	183
Deep water	184
Traveling abroad	184
Cruise control	185
Brake assist system (BAS)	188
Antilock brake system (ABS)	190
ABS control	191
Electronic Stability Program (ESP)	192
Synchronizing ESP	193
ESP Control Switch	194
Level control system	196
Level control switch positions	196
Normal Level	197
Wheel Change Switch	198
Adaptive Damping System (ADS)	199

Adaptive damping system adjustment	199
What you should know at the gas station	200
Fuel supply	200
Fuel	200
Check regularly and before a long trip	202

Instrument cluster display

Malfunction and indicator lamps in the instrument cluster	204
On-board diagnostic system	
Check engine malfunction indicator lamp	204
Brake warning lamp	204
Brake pad wear indicator lamp	205
Seat belt warning lamp	206
Supplemental restraint system (SRS) indicator lamp	206
Fuel reserve and fuel cap placement warning	207

Electronic stability program (ESP) - warning lamp	207
BAS-/ESP malfunction indicator lamp	207
ABS malfunction indicator lamp	208
Low engine coolant level warning lamp	209
Low windshield and headlamp washer system fluid level warning lamp	210
Low engine oil level warning lamp	210
Charge indicator lamp	211
Exterior lamp failure indicator lamp	211
Roll bar warning lamp	212
ADS indicator lamp	212
High beam indicator lamp	213
Additional function indicator lamps (in the odometer display)	213
Malfunction and indicator lamp (in the dashboard)	213

Passenger airbag indicator lamp	213
---------------------------------------	-----

Practical hints

First aid kit	215
Stowing things in the vehicle	215
Vehicle tools	216
Vehicle jack	217
Fuses	218
Hood	219
Automatic transmission fluid level	221
Checking engine oil level	221
Coolant level	223
Adding coolant	224
Windshield and headlamp washer fluid mixing ratio	225
Wheels	226
Tire replacement	226
Rotating wheels	227
Spare wheel	228
Changing wheels	230
Tire inflation pressure	234
Battery	236

Battery Recycling	237
Jump starting	238
Towing the vehicle	240
Exterior lamps	242
Headlamp assembly (Halogen)	243
Taillamp assemblies	249
Changing batteries in the remote control	251
Synchronizing	252
Raising soft top manually	253
Replacing wiper blade insert	257
Manual release of fuel filler flap	259
Trunk lamp	259

Vehicle care

Cleaning and care of the vehicle	261
Power washer	262
Tar stains	262
Paintwork, Painted Body Components	262
Engine cleaning	263

Vehicle washing	263
Ornamental moldings	263
Headlamps, taillamps, turn signal lenses	263
Window cleaning	264
Light alloy wheels	264
Instrument cluster	264
Steering wheel and gear selector lever	264
Cup holder	264
Seat belts	265
Headliner, shelf behind roll bars, and other hard plastic trim items	265
Soft top	265
Headliner	266
Wind screen	266
Automatic antenna	266
Wiper blade	266
Headlamp cleaning system	266
Leather upholstery	267
Plastic and rubber parts	267
Illuminated door sill panels	267

Technical data

Spare parts service	269
Warranty coverage	269
Identification labels	270
Layout of poly-V-belt drive	271
Engine	272
Rims - Tires	273
Weights	275
Main Dimensions	275

Fuels, coolants, lubricants etc. - capacities	276
Engine oils	278
Engine oil additives	278
Air conditioner refrigerant	278
Brake fluid	278
Premium unleaded gasoline	279
Fuel requirements	279
Gasoline additives	280
Coolants	280
Consumer information	282

Index

Index	285
-------------	-----

Product information

Kindly observe the following in your own best interest:

We recommend using Mercedes-Benz original parts as well as conversion parts and accessories explicitly approved by us for your vehicle model.

We have tested these parts to determine their reliability, safety and their special suitability for Mercedes-Benz vehicles.

We are unable to make an assessment for other products and therefore cannot be held responsible for them, even if in individual cases an official approval or authorization by governmental or other agencies should exist. Use of such parts and accessories could adversely affect the safety, performance or reliability of your vehicle. Please do not use them.

Mercedes-Benz original parts as well as conversion parts and accessories approved by us are available at your authorized Mercedes-Benz Center where you will receive comprehensive information, also on permissible technical modifications, and where proper installation will be performed.

Operator's manual

This Operator's Manual contains a great deal of useful information. We urge you to read it carefully and familiarize yourself with the vehicle before driving.

For your own safety and longer service life of the vehicle, we urge you to follow the instructions and warnings contained in this manual. Ignoring them could result in damage to the vehicle or personal injury to you or others. Vehicle damage caused by failure to follow instructions is not covered by the Mercedes-Benz Limited Warranty.

Your vehicle may have some or all of the equipment described in this manual. Therefore, you may find explanations for optional equipment not installed in your vehicle. If you have any questions about the operation of any equipment, your authorized Mercedes-Benz Center will be glad to demonstrate the proper procedures.

Service and warranty information

The Service and Warranty Information Booklet contains detailed information about the warranties covering your Mercedes-Benz, including:

- New Car Limited Warranty,
- Emission System Warranty,
- Emission Performance Warranty,
- California, Massachusetts, and Vermont Emission Control System Warranty (California, Massachusetts, and Vermont only),
- State Warranty Enforcement Laws (Lemon Laws).

Important notice for California retail buyers of Mercedes-Benz automobiles

Under California law you may be entitled to a replacement of your vehicle or a refund of the purchase price, if Mercedes-Benz USA, LLC or its authorized Mercedes-Benz Center fails to conform the vehicle to its express warranties after a reasonable number of repair attempts during the period of one year or 12 000 miles from original delivery of the vehicle. A reasonable number of repair attempts is presumed for a retail buyer (1) if the vehicle is out of service by reason of repair of substantial nonconformities for a cumulative total of more than 30 calendar days or (2) the same substantial non-conformity has been subject to repair four or more times **and you have at least once directly notified us in writing of the need to repair the non-conformity and have given us an opportunity to perform the repair ourselves. Notifications should be sent to the nearest Mercedes-Benz Regional Office listed in the Service and Warranty Information Booklet.**

Maintenance

The Service Booklet describes all the necessary maintenance work which should be performed at regular intervals.

Always have the Service Booklet with you when you take the vehicle to your authorized Mercedes-Benz Center for service. The service advisor will record each service in the booklet for you.

Roadside assistance

The Mercedes-Benz Roadside Assistance Program provides factory trained technical help in the event of a breakdown. Calls to the toll-free Roadside Assistance number:

1-800-FOR-MERCEdes (in the USA)

1-800-387-0100 (in Canada)

will be answered by Mercedes-Benz Client Assistance Representatives 24 hours a day, 365 days a year.

For additional information refer to the Mercedes-Benz Roadside Assistance Program brochure in your glove box.

Change of address or ownership

If you change your address, be sure to send in the “Change of Address Notice” found in the Service and Warranty Information Booklet, or simply call the Mercedes-Benz Client Assistance Center (in the USA) at 1-800-FOR-MERCEdes, or Customer Service (in Canada) at 1-800-387-0100. It is in your own interest that we can contact you should the need arise.

If you sell your Mercedes, please leave all literature with the vehicle to make it available to the next operator.

If you bought this vehicle used, be sure to send in the “Notice of Purchase of Used Car” found in the Service and Warranty Information Booklet, or call the Mercedes-Benz Client Assistance Center (in the USA) at 1-800-FOR-MERCEdes, or Customer Service (in Canada) at 1-800-387-0100.

Operating your vehicle outside the USA or Canada

If you plan to operate your vehicle in foreign countries, please be aware that:

- Service facilities or replacement parts may not be readily available,
- unleaded gasoline for vehicles with catalytic converters may not be available; the use of leaded fuels will damage the catalyts,
- gasoline may have a considerably lower octane rating, and improper fuel can cause engine damage.

Certain Mercedes-Benz models are available for delivery in Europe under our European Delivery Program. For details, consult your authorized Mercedes-Benz Center or write to:

In the USA:

Mercedes-Benz USA, LLC
European Delivery Department
One Mercedes Drive
Montvale, NJ 07645-0350

In Canada:

Mercedes-Benz Canada, Inc.
European Delivery Department
849 Eglinton Avenue East
Toronto, Ontario M4G 2L5

We continuously strive to improve our product, and ask for your understanding that we reserve the right to make changes in design and equipment. Therefore, information, illustrations and descriptions in this Operator's Manual might differ from your vehicle.

Optional equipment is also described in this manual, including operating instructions wherever necessary. Since they are special-order items, the descriptions and illustrations herein may vary slightly from the actual equipment of your vehicle.

If there are any equipment details that are not shown or described in this Operator's Manual, your authorized Mercedes-Benz Center will be glad to inform you of correct care and operating procedures.

The Operator's Manual and Service Booklet are important documents and should be kept with the vehicle.

Where to find it

The Operator's Manual is divided into eight sections:

- **Instruments and controls:** An overview of all the controls that can be operated from the driver's seat.
- **Operation:** Information on the vehicle's equipment and its operation.
- **Driving:** Important information on driving.
- **Instrument cluster display:** Displays and indicator lamps on the instrument cluster with brief instructions.
- **Practical hints:** Assistance and instructions in the event of an emergency.
- **Car care:** Instructions on caring for your vehicle.
- **Technical data:** All the important technical data for your vehicle as well as consumer information such as fuels, coolants, lubricants etc. is contained here.
- **Index:** Key terms to help you find a topic quickly.

Other documents may also be supplied, depending on your vehicle's equipment.

Explanation of color used:

Warning notices for the protection of yourself and others appear on red background.

Problems with your vehicle

If you should experience a problem with your vehicle, particularly one that you believe may affect its safe operation, we urge you to immediately contact your authorized Mercedes-Benz Center to have the problem diagnosed and corrected if required. If the matter is not handled to your satisfaction, please discuss the problem with the Mercedes-Benz Center management, or if necessary contact us at the following addresses:

In the USA: Client Assistance Center
 Mercedes-Benz USA, LLC
 One Mercedes Drive
 Montvale, NJ 07645-0350

In Canada: Customer Relations Department
 Mercedes-Benz Canada, Inc.
 849 Eglinton Avenue East
 Toronto, Ontario, M4G 2L5

For the USA only:

The following text is published as required of manufacturers under Title 49, Code of U.S. Federal Regulations, Part 575 pursuant to the “National Traffic and Motor Vehicle Safety Act of 1966”.

Reporting Safety Defects

If you believe that your vehicle has a defect which could cause a crash or could cause injury or death, you should immediately inform the National Highway Traffic Safety Administration (NHTSA) in addition to notifying Mercedes-Benz USA, LLC.

If NHTSA receives similar complaints, it may open an investigation, and if it finds that a safety defect exists in a group of vehicles, it may order a recall and remedy campaign. However, NHTSA cannot become involved in individual problems between you, your retailer, or Mercedes-Benz USA, Inc.

To contact NHTSA, you may either call the Auto Safety Hotline toll-free at 1-800-424-9393 (or 366-0123 in Washington, D.C. area) or write to: NHTSA, U.S. Department of Transportation, Washington, D.C. 20590. You can also obtain other information about motor vehicle safety from the Hotline.

Instruments and controls

Instruments and controls	18
Door control panel	20
Overhead control panel	21
Dashboard	22
Center console	24

Instruments and controls



1 Door control panel, see page 20

2 Overhead control panel, see page 21

3 Dashboard, see page 22

4 Center console, see page 24

Instruments and controls

20

Door control panel



- 1 Door handle, pull to open, see page 35
- 2 Front seat adjustment, see page 44
Memory function (for storing seat, head restraint, steering wheel and exterior rear view mirror settings), see page 46

Overhead control panel

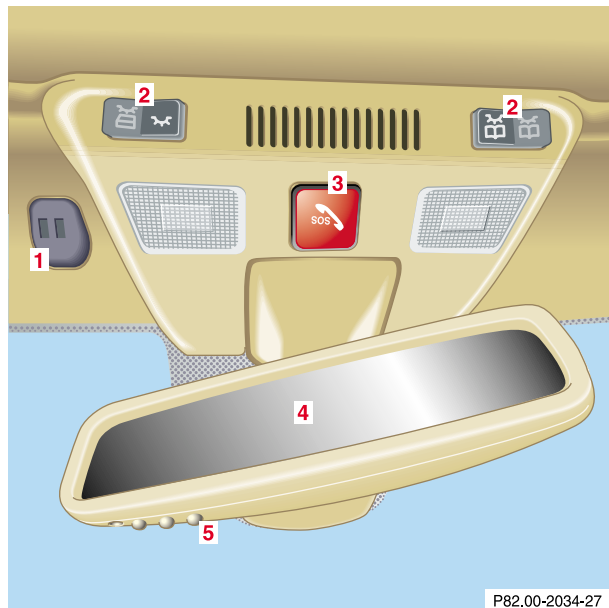

- 1 Hands-free microphone for Tele Aid, and optional telephone with voice recognition system
- 2 Interior lighting, see page 120
- 3 Tele Aid (emergency call system), see page 155
- 4 Rear view mirror, see page 71
- 5 Garage door opener, see page 133

Instruments and controls

22

Dashboard

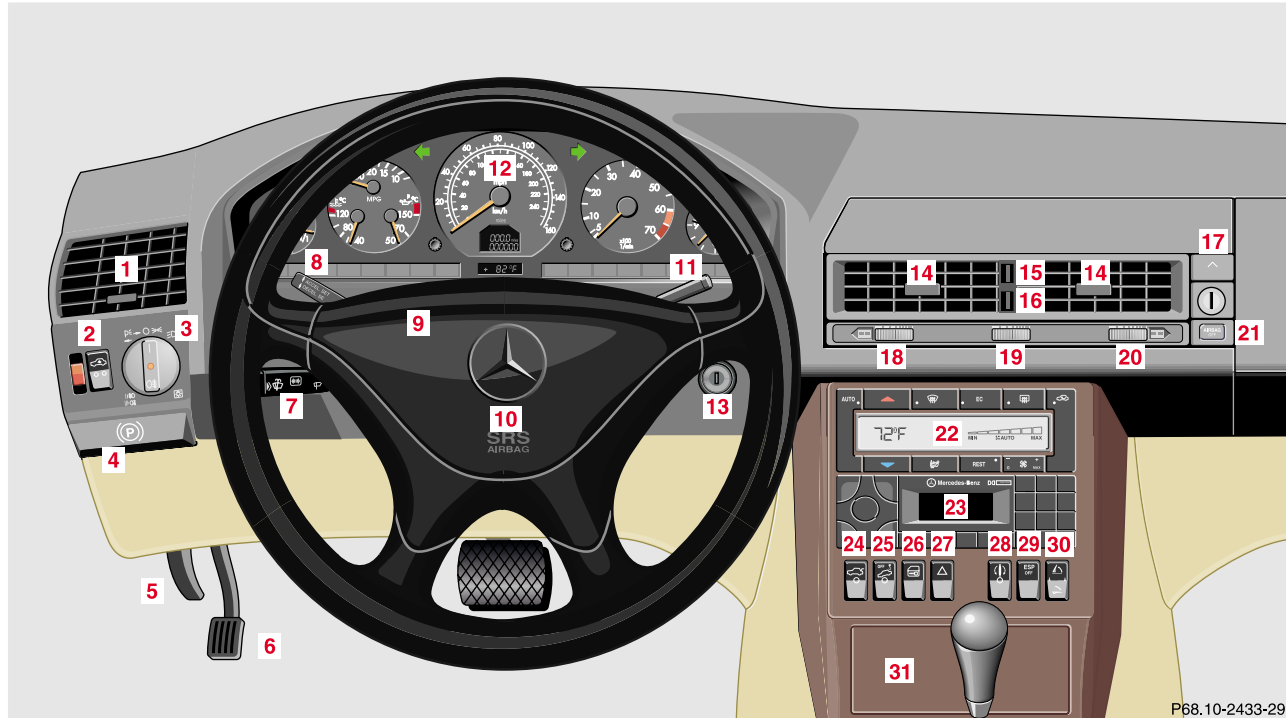

P68.10-2433-29

- 1 Side air outlet, adjustable, see page 91
- 2 Level control switch and wheel change switch, see page 196
- 3 Exterior lamp switch, see page 86
- 4 Parking brake release, see page 175
- 5 Hood lock release, see page 219
- 6 Parking brake pedal, see page 175
- 7 Combination switch, see page 86
- 8 Cruise control switch, see page 185
- 9 Horn
- 10 Airbag, see page 60
- 11 Voice recognition system switch, see separate operating instructions
- 12 Instrument cluster, see page 74
- 13 Steering lock with ignition/starter switch, see page 165
- 14 Center air outlets adjustable, see page 91
- 15 Heated air supply button - center air outlet, see page 91
- 16 Non-heated/cooled air supply button - center air outlet, see page 91
- 17 Storage/eyeglasses compartment, see page 124
- 18 Air volume control for left air outlet, see page 91
- 19 Air volume control for center air outlets, see page 91
- 20 Air volume control for right air outlet, see page 91
- 21 Airbag off indicator lamp, see page 213
- 22 Automatic climate control, see page 90
Rear window defroster switch, see page 95
- 23 Audio system, see page 98
- 24 Trunk lid release switch, see page 40
- 25 Switch for tow-away alarm, see page 43
Indicator lamp for antitheft alarm system, see page 42
- 26 Central locking switch, see page 37
- 27 Hazard warning flasher switch, see page 89
- 28 Adaptive damping system adjustment switch, see page 199
- 29 ESP control switch, see page 194
- 30 Roll bar operation switch, see page 118

Instruments and controls

Center console

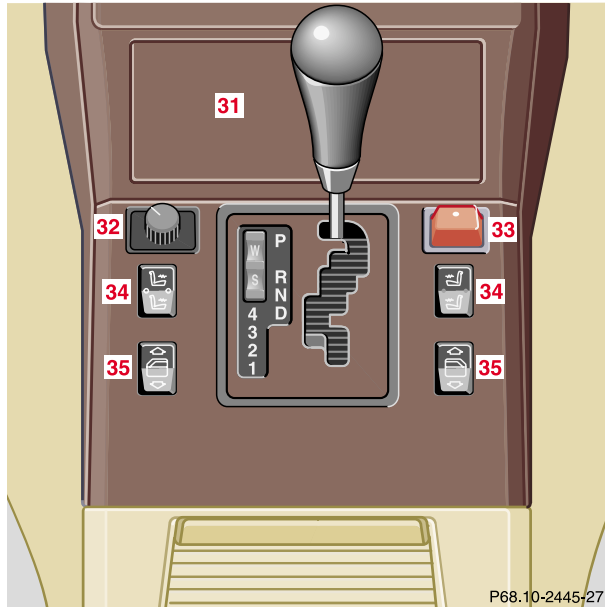

P68.10-2445:27

24

- 31 Ashtray with lighter (to open press bottom of cover), see page 130
- 32 Mirror adjustment switch, see page 72
- 33 Soft/hardtop operation switch, see page 143
- 34 Seat heater switch, see page 50
- 35 Power window switch, see page 116

Instruments and controls	Operation	Driving	Instrument cluster display	Practical hints	Car care	Technical data	Index
---------------------------------	------------------	----------------	-----------------------------------	------------------------	-----------------	-----------------------	--------------

Instruments and controls

25

Contents – Operation

26

Operation

Vehicle keys28	Tow-away alarm 43	Safety guidelines for the seat belt, emergency tensioning retractor and airbag66
Remote control with folding master key28	Power seats 44	Infant and child restraint systems67
Central locking system30	Storing position in memory 46	Adjusting steering column70
Remote control30	Backrest 48	Storing steering column position in memory70
Locking and unlocking 31	Multicontour seats 49	Rear view mirrors 71
Choosing global or selective mode on remote control32	Seat heater 50	Inside rear view mirror 71
Opening the trunk32	Seat belts and integrated restraint system 52	Antiglare night position 71
Panic button33	Seat belts 52	Exterior rear view mirrors72
Start lock-out34	Seat belt nonusage warning system 53	Storing mirror positions in memory73
General notes on the central locking system 34	Fastening of seat belts 54	Instrument cluster 74
Doors35	BabySmart™ airbag deactivation system 58	Indicator lamps in the instrument cluster 76
Central locking switch37	Self-test BabySmart™ without special child seat installed 59	Additional function indicator lamps77
Automatic central locking38	Supplemental restraint system (SRS) 59	Instrument lamps77
Emergency unlocking in case of accident39	Emergency tensioning retractor (ETR) 60	Display illumination77
Trunk39	Airbags 60	Coolant temperature gauge78
Trunk lid release switch40	Front airbags 62	Outside temperature indicator78
Power windows 41	Side impact airbags 63	
Antitheft alarm system42		

Trip odometer	79	Audio and telephone, operation	98	Separate locking of storage compartments	126
Clock	79	Power windows	116	Armrest	127
Tachometer	79	Express opening of door windows	117	Console storage compartments	127
Flexible service system (FSS)	80	Synchronizing power windows	117	Cup holder	128
Engine oil level indicator in odometer display field	82	Roll bar	118	Parcel net in passenger footwell	128
Fuel consumption gauge	83	Interior lighting	120	Door pockets	129
Engine oil temperature gauge	83	Interior lamps	120	Rear storage compartment	129
Engine oil consumption	83	Reading lamps	120	Ashtray with lighter	130
Exterior lamp switch	84	Entrance lamps in footwells, exit lamps in doors	120	Lighter	131
Standing lamps	85	Sunshade, manual	121	Telephone, general	132
Night security illumination	85	Power sunshade	122	Garage door opener	133
Combination switch	86	Sun visors	123	Hardtop or panorama roof	137
Blocked windshield wiper	88	Illuminated vanity mirror	123	Removing hardtop	137
Windshield wiper smears	88	Interior	124	Attaching hardtop	140
Windshield and headlamp washer fluid mixing ratio	88	Storage compartment (eyeglasses compartment) in the dashboard	124	Soft top	143
Hazard warning flasher switch	89	Interior central locking system	125	Lowering soft top	144
Automatic climate control	90	Integration with vehicle central locking system	126	Raising soft top	145
Display and controls	92			Wind screen	148
Basic setting - automatic mode ..	93			Antenna	151
Economy	93				
Special settings	94				

Central locking system

28

Vehicle keys

Included with your vehicle are:

- 2 remote controls with folding master keys,
- 1 valet key.

Warning!

When leaving the vehicle always remove the key from the steering lock, and lock your vehicle. Do not leave children unattended in the vehicle, or with access to an unlocked vehicle. Unsupervised use of vehicle equipment may cause serious personal injury.

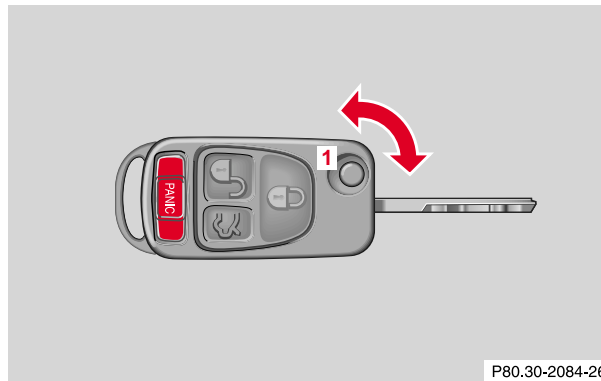
Remote control with folding master key

P80.30-2084-26

The remote control operates all locks on the vehicle.

To release the key, press button (1). The key unfolds from the holder by itself.

The transmitter for the remote control is located in the key holder.

The infrared receivers are located in the door handles.

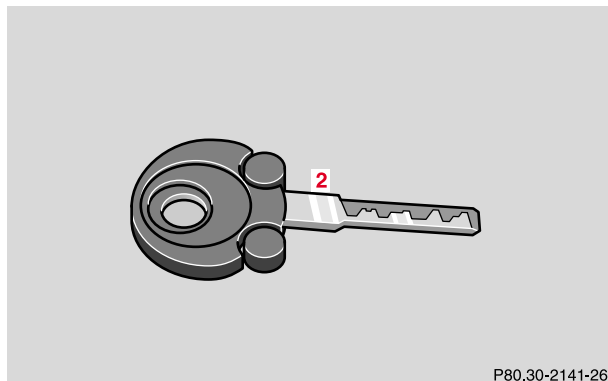

The valet key (2) works only in the driver's door lock and the steering lock.

The valet key (2) will not work in the trunk and storage compartment locks.

To prevent access to trunk by using the valet key (2), the luggage cover must be open.

Notes:

Do not give the master key to an unauthorized person.

Obtaining replacement keys

Your vehicle is equipped with a theft deterrent locking system requiring a special key manufacturing process. For security reasons, replacement keys can only be obtained from your authorized Mercedes-Benz Center.

Central locking system

30

Central locking system**Remote control**

Due to the extended operational range of the remote control, it could be possible to unintentionally lock or unlock the vehicle by pressing the transmit button.

The vehicle doors, trunk, storage compartment in armrest, and fuel filler flap can be centrally locked and unlocked via remote control.

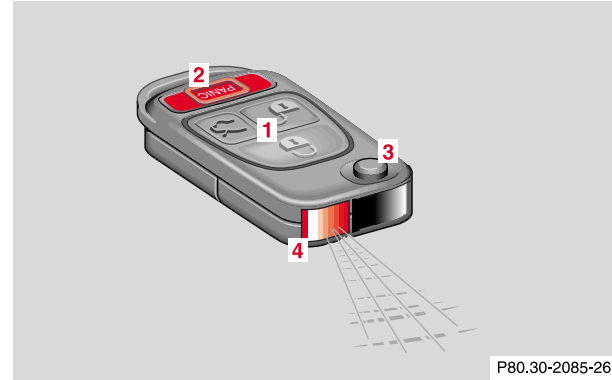

1 Transmit button



Locking



Unlocking



Opening trunk

2 PANIC button

3 Release button for master key

4 Transmitter eye and lamp for battery check

Locking and unlocking with remote control

Unlocking:

Press transmit button . All turn signal lamps blink once to indicate that the vehicle is unlocked.

The remote control can be programmed for two kinds of unlocking modes (see below):

Selective unlocking mode –

Press transmit button  once to unlock driver's door, storage compartment in armrest, and fuel filler flap.

Press transmit button  twice to unlock both doors, storage compartment in armrest, fuel filler flap, and trunk.

Global unlocking mode –

Press transmit button  once to unlock both doors, storage compartment in armrest, fuel filler flap, and trunk.

Notes:

If the trunk was previously locked separately, it will remain locked, see page 39.

The presently active unlocking mode (selective or global) can only be determined by unlocking the vehicle with the remote control (see below for changing mode).

If within 40 seconds of unlocking with the remote control, neither door is opened, the key is not inserted in the steering lock, or the central locking switch is not activated, the vehicle will automatically lock.

Locking:

Press transmit button  once. All turn signal lamps blink three times to indicate that the vehicle is locked.



Note:

If the vehicle cannot be locked or unlocked by pressing the transmit button, then it may be necessary to change the batteries in the remote control (if ok, battery check lamp in transmitter will light briefly when transmitting) or to synchronize the remote control, see page 251 and page 252.

Central locking system

32

Choosing global or selective mode on remote control

Press and hold transmit buttons  and  simultaneously for five seconds to reprogram the remote control. Battery check lamp will blink two times indicating the completed mode change.

Opening the trunk

Press the transmit button  until the trunk lid is open.

Important!

Do not place remote control in trunk since trunk is locked when the lid is closed if the vehicle is centrally locked.

Note:

If the trunk was previously locked separately, it will remain locked. See page 39.

Panic button

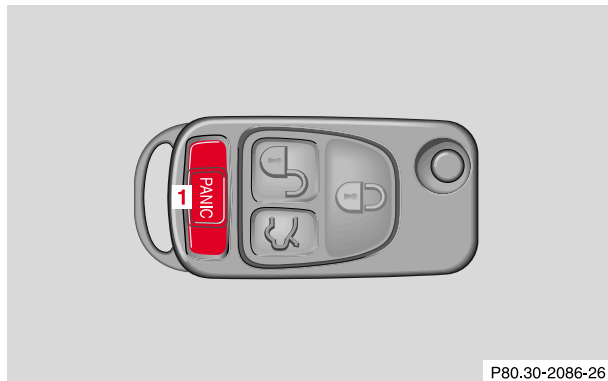

To activate press and hold button (1) for at least one second. An audible alarm and blinking exterior lamps will operate for approximately 3 minutes.

To deactivate press button (1) again, or turn key in steering lock to position 2.

Note:

For operation in the USA only: This device complies with Part 15 of the FCC Rules. Operation is subject to the following two conditions:

- (1) This device may not cause harmful interference, and
- (2) this device must accept any interference received, including interference that may cause undesired operation.

Any unauthorized modification to this device could void the user's authority to operate the equipment.

Central locking system

34

Start lock-out**Important!**

Removing the key from the steering lock activates the start lock-out. The engine cannot be started.

Turning the key in the steering lock to position 2 deactivates the start lock-out.



Note:

In case the engine cannot be started (vehicle's battery is in order), and **Service** and **Error** are shown in the odometer display field, the system is not operational. Contact an authorized Mercedes-Benz Center or call 1-800-FOR-MERCEdes (in the USA), or 1-800-387-0100 (in Canada).

General notes on the central locking system

- If the key in the steering lock is in position 2, the vehicle cannot be locked or unlocked with the remote control.

If the vehicle cannot be locked or unlocked:

- Aim transmitter eye at a receiver of either door handle and press button  or .
- Check the batteries of the remote control, see page 251.
- Synchronize the central locking system, see page 252.

Doors

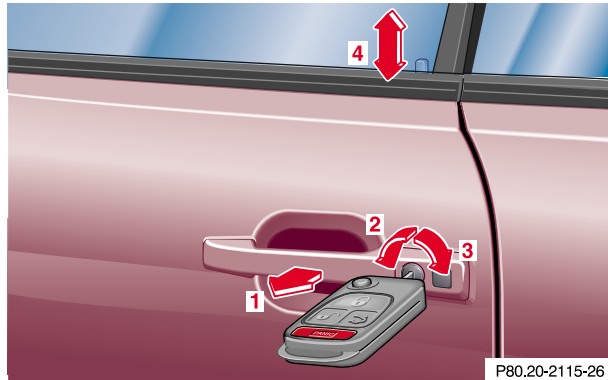

- 1 Opening – pull handle
- 2 Unlocking
- 3 Locking
- 4 Individual door from inside:
 - Push lock button down to lock.
 - Pull inside door handle to unlock.

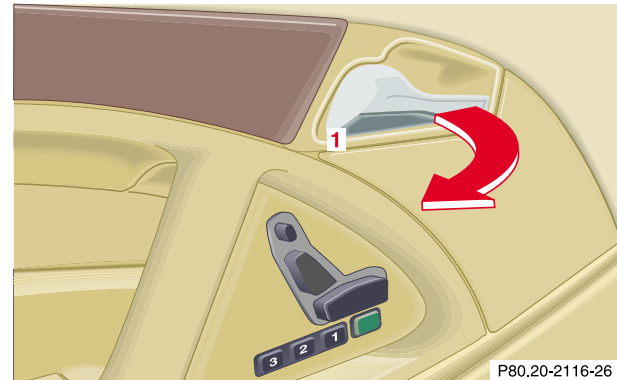

The entire vehicle may be locked or unlocked by either using the master key in driver's door or trunk locks, or central locking switch located in center console. The master key also locks or unlocks the storage compartment in the armrest, and the fuel filler flap.

Note:

If the fuel filler flap cannot be opened, see page 259.

Central locking system

36

When you lock the vehicle, both door lock buttons should move down. If any one stays up, the respective door is not properly closed.

You should then unlock the vehicle, open and reclose this door, and lock the vehicle again. Each individual door can be locked with door lock button – the driver's door can only be locked when it is closed.

If the vehicle has previously been locked from the outside, only the door being opened from the inside will unlock, and the alarm will come on. The other door, the trunk, the interior storage compartments, and fuel filler flap remain locked.

Notes:

In case of a malfunction in the central locking system the doors can be locked and unlocked individually.

To lock, turn key in driver's door lock to position 3 or push down lock buttons.

To unlock, turn key in driver's door lock to position 2 or pull inside door handles.

Central locking switch

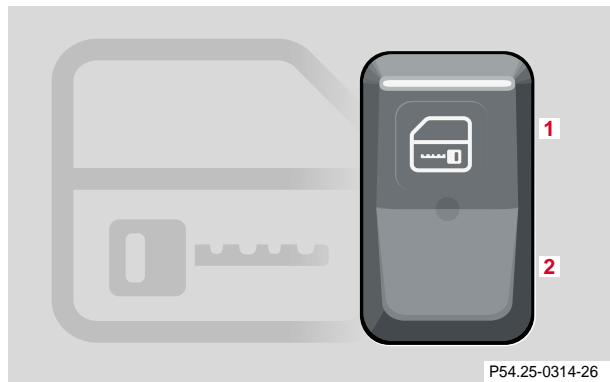

1 Locking

2 Unlocking

The central locking switch is located in the center console.

The doors and trunk can only be locked with the central locking switch, if both doors are closed.

Notes:

If the vehicle was previously locked with the remote control or key, the doors and trunk cannot be unlocked with the central locking switch.

Opening a door with the inside door handle will cause the alarm to come on. To switch the alarm off, press  button or insert key in steering lock and turn it to position 1.

If the vehicle was previously locked with the central locking switch, while in the selective remote control mode, only the door opened from the inside is unlocked.

If the vehicle was previously locked with the central locking switch, while in the global remote control mode, the complete vehicle is unlocked when a door is opened from the inside.

Note:

The storage compartment in the armrest as well as the fuel filler flap cannot be locked or unlocked with the central locking switch.

Central locking system

38

Automatic central locking

The central locking switch also operates the automatic central locking.

With the automatic central locking system activated, the doors and trunk are locked at vehicle speeds of approx. 9 mph (15 km/h) or more. The fuel filler flap remains unlocked.

To activate:

With key in steering lock position 2 hold upper portion of switch (1) for a minimum of 5 seconds.

To deactivate:

With key in steering lock position 2 hold lower portion of switch (2) for a minimum of 5 seconds.

Notes:

If doors are unlocked with the central locking switch after activating the automatic central locking, and neither door is opened, then the doors remain unlocked even at vehicle speeds of approx. 9 mph (15 km/h) or more.

If a door is opened from the inside at speeds of approx. 9 mph (15 km/h) or less with the automatic central locking activated, the door will again be automatically locked at speeds of approx. 9 mph (15 km/h) or more.

Important!

When towing the vehicle, or with the vehicle on a dynamometer test stand, please, note the following:

With the automatic central locking activated and the key in steering lock position 2, the vehicle doors will lock if the left front wheel as well as the right rear wheel spin are turning at vehicle speeds of approx. 9 mph (15 km/h) or more.

To prevent the vehicle door locks from locking, deactivate the automatic central locking.

Emergency unlocking in case of accident

The doors unlock automatically a short time after a strong deceleration is detected, such as in a collision (this is intended to aid rescue and exit). Driving on rough roads may cause the vehicle to unlock. If necessary, the vehicle can be locked again with the interior central locking switch.

Trunk

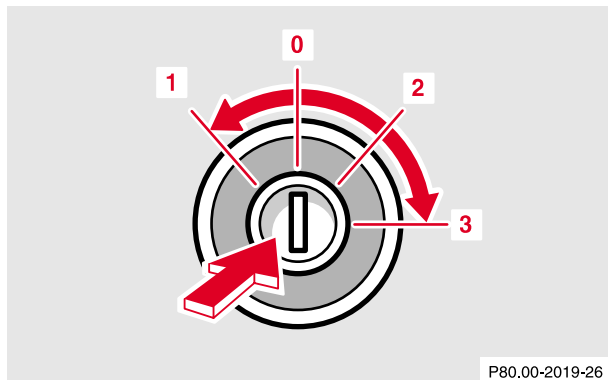

- 0 Neutral position – push to open (arrow)
- 1 Unlocking
- 2 Locking (detent)
- 3 Separate locking of trunk – remove key in this position.

When the trunk is separately locked, it remains locked when centrally unlocking the vehicle.

To deny any unauthorized person access to the trunk, lock it separately with the mechanical key. Leave only the valet key with the vehicle.

Notes:

In case of a malfunction in the central locking system the trunk can be locked and unlocked individually.

To lock, turn key to position 2 or 3.

To unlock and open the trunk lid, turn key to position 1, hold and push to open.

If the fuel filler flap cannot be opened, see page 259.

Important!

Do not place key inside trunk, since trunk is locked again when closing the lid.

Lower trunk lid using handle and close it with hands placed flat on edges on trunk.

Central locking system

40

Trunk lid release switch

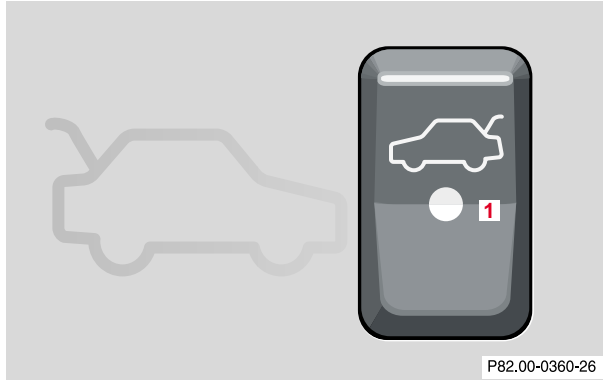

1 Indicator lamp in switch located in center console

To release the trunk lid, the vehicle must be at standstill and unlocked with the remote control. Press symbol side of switch until trunk lid is released.

The indicator lamp (1) in the switch remains on with trunk lid released.

Notes:

With vehicle centrally locked, the trunk can also be released by using the remote control. Press  button one second.

The trunk lid cannot be released by the switch when previously locked separately with the key. To open, see page 39.

The trunk lid cannot be opened with the trunk lid release switch when the vehicle was previously locked with the remote control. To unlock vehicle with the remote control, see page 30.

Power windows

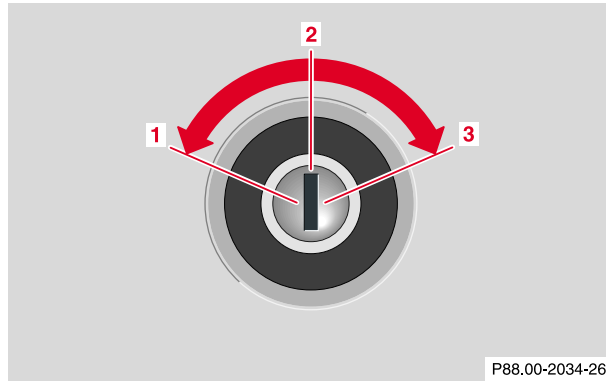

- 1 Opening
- 2 Interrupting
- 3 Closing

When locking doors or trunk, turn key in door lock or trunk lock to position 3 and hold. The windows begin to close automatically after approximately 1 second.

To interrupt the closing procedure, turn key to position 2.

When unlocking doors or trunk, turn key in door lock or trunk lock to position 1 and hold. The windows begin to open automatically after approximately 1 second.

To interrupt the opening procedure, turn key to position 2.

Warning!

Never operate the windows if there is the possibility of anyone being harmed by the procedure.

In case the procedure causes potential danger, the procedure can be immediately reversed by turning the key to the reversed operational direction within 10 seconds:

- for opening position (1),
- for closing position (3).

Note:

If the opening/closing procedure is interrupted, it can only be continued by first turning the key to the interrupting position (2) and then again to the opening/closing position (1 or 3) and hold.

Antitheft alarm system

42

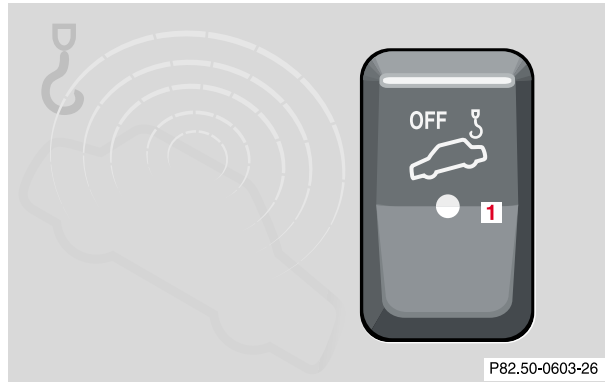
Antitheft alarm system**1** Indicator lamp in switch located in center console

The antitheft alarm is automatically armed or disarmed with the remote control or any of your vehicle's keys by locking or unlocking the vehicle.

The antitheft alarm is armed within approx. 10 seconds after locking the vehicle.

A blinking lamp (1) indicates that the alarm is armed.

Operation:

Once the alarm system has been armed, the exterior vehicle lamps will flash and an alarm will sound when someone:

- opens a door,
- opens the trunk,
- opens the hood,
- opens the storage compartment between the front seats,
- attempts to raise the vehicle.

The alarm will last approximately 3 minutes in form of flashing exterior lamps. At the same time an alarm will sound for 30 seconds. The alarm will stay on even if, for example, an opened door is immediately closed again. If the alarm stays on for more than 20 seconds, an emergency call is initiated automatically. See Tele Aid on page 155.

The antitheft alarm system is switched off automatically if the vehicle is unlocked with the electronic main key.

Tow-away alarm



The switch is located in the center console.

- 1 Press to switch off
- 2 Indicator lamp

Once the alarm system has been armed, the exterior vehicle lamps will flash and an alarm will sound when someone attempts to raise the vehicle.

The alarm will last approximately 3 minutes in the form of flashing exterior lamps. At the same time an alarm will sound for 30 seconds. The alarm will stay on even if the vehicle is immediately lowered.

The tow-away alarm system is switched off automatically if the vehicle is unlocked with the electronic main key.

If the alarm stays on for more than 20 seconds, an emergency call is initiated automatically. See Tele Aid on page 155.

To prevent triggering the tow-away alarm feature, switch off the tow-away alarm before towing the vehicle, or when parking on a surface subject to movement, such as a ferry or auto train.

To do so, turn key in steering lock to position 1 or 0, or remove key from steering lock. Press tow-away alarm switch (1). The indicator lamp (2) illuminates briefly.

Exit vehicle, and lock vehicle with key or remote control.

The tow-away alarm remains switched off until the vehicle is locked again with key or remote control, at which time it is automatically reactivated.

Seats

44

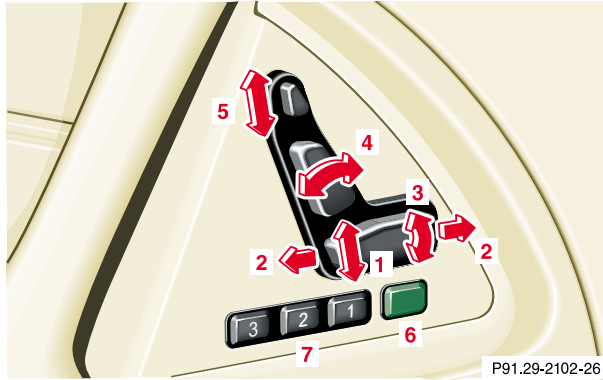
Power seats

The switches are located in both doors.

Turn key in steering lock to position 1 or 2 (with either door open, the power seats can also be operated with the key removed or in steering lock position 0).

The position should be as far rearward as possible, consistent with ability to properly operate controls.

We recommend to adjust the power seat in the following order:

1 Seat, up/down

Press the switch (up/down direction) until comfortable seating position with still sufficient headroom is reached.

2 Seat adjustment, fore/aft

Press the switch (fore/aft direction) until a comfortable seating position is reached that still allows you to reach the accelerator/brake pedal safely.

3 Seat cushion tilt

Press the switch in the direction of the arrow until your legs are lightly supported.

4 Backrest tilt

Press the switch in the direction of the arrow until the backrest is in an almost upright position. Adjust the steering wheel until your arms are slightly angled when holding the steering wheel. For steering wheel adjustment see page 70.

5 Head restraint

(with shoulder belt height adjustment)

Adjust the head restraint so that the upper portion of the shoulder belt is located as close as possible to the middle of the shoulder. The head restraint can be tilted forward by hand.

Note:

To prevent the backrest from touching the soft top storage compartment cover when the seat is moved back, the backrest will automatically move to a more upright position.

When reclining the backrest, the seat will automatically move forward to prevent the backrest from touching the soft top storage compartment cover.

Warning!

When leaving the vehicle always remove the key from the steering lock, and lock the vehicle.

The power seats can also be operated with a door open. Do not leave children unattended in the vehicle, or with access to an unlocked vehicle.

Unsupervised use of vehicle equipment may cause serious personal injury.

Do not adjust the driver's seat while driving. Adjusting the seat while driving could cause the driver to lose control of the vehicle.

Never ride in a moving vehicle with the backrest reclined.

Sitting in an excessively reclined position can be dangerous. You could slide under the seat belt in a collision. If you slide under it, the belt would apply force at the abdomen or neck. That could cause serious or even fatal injuries. The backrest and seat belt provide the best restraint when the wearer is in an upright position and the belt is properly positioned on the body.

The rear storage area should never be occupied by passengers since the vehicle is a 2 seater. Furthermore, there is a risk of injury in the rear by adjusting the power assisted front seats.

Never place hands under seat or near any moving parts while a seat is being adjusted.

Storing position in memory

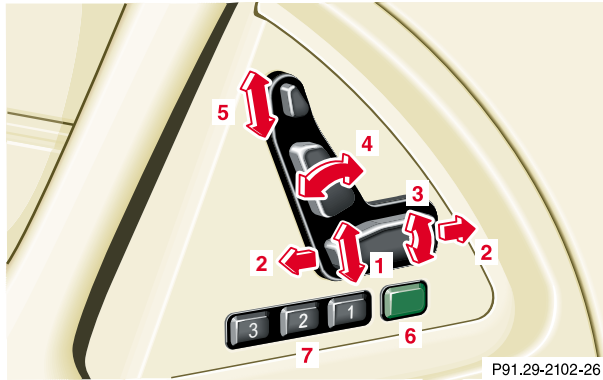

6 Memory button

7 Position buttons “1”, “2” and “3”

After the seat and head restraint are positioned, push memory button (6), release, and within 3 seconds push position button “1”. Two additional sets of positions may be stored into memory using position buttons “2” and “3”.

Using the same position button, the steering wheel position and exterior rear view mirror positions will also be stored together with the seat position. For adjusting steering wheel and mirrors see page 70.

Recalling stored positions

Press position button “1”, “2” or “3” and hold until seat/head restraint/steering wheel/exterior rear view mirror movement has stopped.

Note:

For safety reasons, the seat/head restraint/steering wheel/exterior rear view mirror movement stops after releasing the position button.

Important!

Prior to operating the vehicle, the driver should adjust the seat height for proper vision as well as fore/aft placement and backrest angle to insure adequate control, reach, operation, and comfort. The head restraint should also be adjusted for proper height. Adjust head restraint to support the back of the head approximately at ear level. See also airbag section for proper seat positioning on page 60.

In addition, also adjust the steering wheel to ensure adequate control, reach, operation, and comfort.

Both the inside and outside rear view mirrors should be adjusted for adequate rearward vision.

Fasten seat belts. Infants and small children should be seated in a properly secured restraint system that complies with U.S. Federal Motor Vehicle Safety Standard 213 and Canadian Motor Vehicle Safety Standard 213.

All seat, head restraint, rear view mirror, and steering wheel adjustments as well as fastening of seat belts should be done before the vehicle is put into motion.

Warning!

Children 12 years old and under must never ride in this vehicle, except in a Mercedes-Benz authorized BabySmart™ compatible child seat, which operates with the BabySmart™ system installed in the vehicle to deactivate the passenger side front airbag when it is properly installed.

Otherwise they will be struck by the airbag when it inflates in a crash. If this happens, serious or fatal injury will result.

Infants and small children must be seated in an appropriate infant or child restraint system, which is properly secured with the vehicle's seat belt, fully in accordance with the child seat manufacturer's instructions.

A child's risk of serious or fatal injuries is significantly increased if the child restraints are not properly secured in the vehicle and the child is not properly secured in the child restraint.

BabySmart™ is a trademark of Siemens Automotive Corp.

Backrest

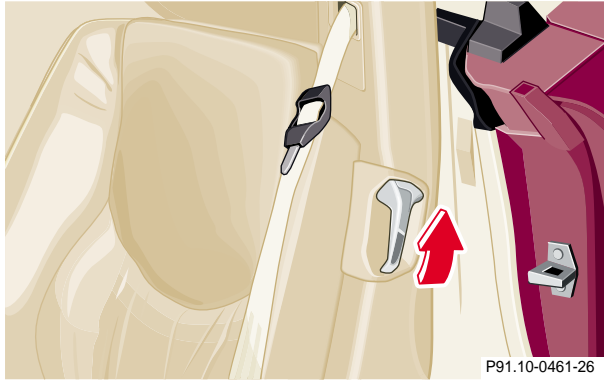

Folding forward:

Lift lever and fold forwards.

Folding back:

Fold backrest back until it audibly locks in place.

Warning

The seat belts provide protection only with the backrest locked in place and, therefore, it must be locked in place with the vehicle in motion. Do not drive the vehicle when the backrest is not locked in place.

Note:

If the backrest and seat belt warning lamp  does not go out, but is instead lit continuously, then a backrest is not engaged in its lock.

Always provide sufficient room behind the backrest and fold the backrest all the way back until it can be heard locking in place.

The warning lamp goes out as soon as both backrests are locked in place.

If both backrests are locked in place and the warning lamp does not go out, have the system checked at your authorized Mercedes-Benz Center immediately.

Multicontour seats (optional)

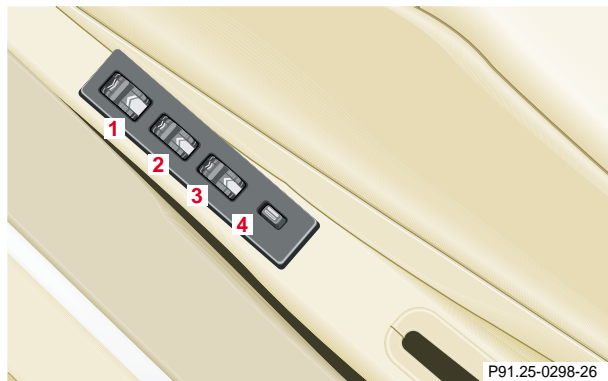

Switch is located on side of seat.

We recommend to adjust the multicontour seat in the following order:

- 1 Seat cushion depth
- 2 Backrest bottom
- 3 Backrest center
- 4 Side bolster adjustment

Some models may be equipped with multicontour seats. These seats have movable seat cushions, and inflatable air cushions built into the backrest to provide additional lumbar and side support.

The seat cushion movement and amount of backrest cushion height and curvature can be continuously varied with regulators (1, 2 and 3) after turning the key in steering lock to position 2.

The side bolsters of the backrest can be adjusted with rocker switch (4):

- press down forward end - increase side support,
- press down rearward end - decrease side support.

If the engine is turned off, the last cushion setting is retained in memory, and automatically adjusts the cushion to this setting when the engine is restarted.

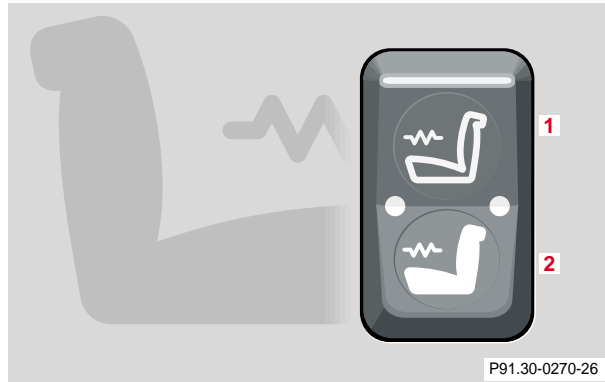
Seat heater (SL 500 optional)

The seat heater switches are located on the center console.

The seat heaters can be switched on with the key in steering lock positions 1 or 2.

Press switch to turn on seat heater:

- 1** Normal seat heating mode. One indicator lamp in the switch lights up.
- 2** Rapid seat heating mode. Both indicator lamps in the switch light up. After approximately 5 minutes in the rapid seat heating mode, the seat heater automatically switches to normal operation and only one indicator lamp will stay on.

Turning off seat heater:

If one indicator lamp is on, press upper half of switch.

If both indicator lamps are on, press lower half of switch.

If left on, the seat heater automatically turns off after approximately 30 minutes of operation.

Note:

When in operation, the seat heater consumes a large amount of electrical power. It is not advisable to use the seat heater longer than necessary.

The seat heaters may automatically switch off if too many power consumers are switched on at the same time, or if the battery charge is low. When this occurs, the indicator lamp in the switch will blink (both indicator lamps blink during rapid seat heating mode). The seat heaters will switch on again automatically as soon as sufficient voltage is available.

If the blinking of the indicator lamps is distracting to you, the seat heaters can be switched off.

Seat belts and integrated restraint system

Your vehicle is equipped with lap-shoulder seat belts, emergency tensioning retractors for the seat belts, as well as airbags and knee bolsters.

Seat belts

Important!

Laws in most states and all Canadian provinces require seat belt use.

All states and provinces require use of child restraints that comply with U.S. Federal Motor Vehicle Safety Standard 213 and Canadian Motor Vehicle Safety Standard 213.

All child restraint systems are designed to be secured in vehicle seats by lap belts or the lap belt portion of a lap-shoulder belt.

For your safety and that of your passenger we strongly recommend their use.

Note:

For cleaning and care of the seat belts, see page 265.

Warning!

The seat belts provide protection only with the backrest locked in place. If the seat belt warning lamp  does not go out, but is instead lit continuously, then a backrest is not engaged in its lock.

Never ride in a moving vehicle with the backrest reclined. Sitting in an excessively reclined position can be dangerous. You could slide under the seat belt in a collision. If you slide under it, the belt would apply force at the abdomen or neck. That could cause serious or even fatal injuries. The backrest and seat belt provide the best restraint when the wearer is in an upright position and the belt is properly positioned on the body.

Seat belt nonusage warning system

With the key in steering lock position 2, a warning sounds for a short time if the driver's seat belt is not fastened.

Warning!

Failure to wear and properly fasten and position your seat belt greatly increases your risk of injuries and their likely severity in an accident. You and your passenger should always wear seat belts.

If you are ever in an accident, your injuries can be considerably more severe without your seat belt properly buckled. Without your seat belt buckled, you are much more likely to hit the interior of the vehicle or be ejected from it. You can be seriously injured or killed.

In the same crash, the possibility of injury or death is lessened if you are wearing your seat belt.

Never let more people ride in the vehicle than there are seat belts available. Be sure everyone riding in the vehicle is correctly restrained with a separate seat belt.

Warning!

Children 12 years old and under must never ride in this vehicle, except in a Mercedes-Benz authorized BabySmart™ compatible child seat, which operates with the BabySmart™ system installed in the vehicle to deactivate the passenger side front airbag when it is properly installed. Otherwise they will be struck by the airbag when it inflates in a crash. If this happens, serious or fatal injury can result.

Infants and small children must be seated in an appropriate infant or child restraint system, which is properly secured with the vehicle's seat belt, fully in accordance with the child seat manufacturer's instructions.

A child's risk of serious or fatal injuries is significantly increased if the child restraints are not properly secured in the vehicle and the child is not properly secured in the child restraint.

BabySmart™ is a trademark of Siemens Automotive Corp.

Restraint systems

Fastening of seat belts



54

- 1 Latch plate
- 2 Buckle
- 3 Release button

Pull belt with latch plate (1) across shoulder and lap.
Push latch plate (1) into buckle (2) until it clicks.

To help avoid severe or fatal injuries, the lap belt should be positioned as low as possible on your hips and not across the abdomen.

Warning!

**Always fasten your seat belt before driving off.
Always make sure your passenger is properly restrained.**

Do not twist the belt. A twisted seat belt may cause injury.



Press switch (4) to adjust the height of the seat belt outlet so that the shoulder portion is located as close as possible to the middle of your shoulder.

The shoulder portion of the seat belt must be pulled snug and checked for snugness immediately after engaging it and during driving. Tighten the lap portion to a snug fit by pulling shoulder portion up.

Operation of seat belts

The inertia reel stops the belt from unwinding during sudden vehicle stops or when quickly pulling on the belt.

The locking function of the reel may be checked by quickly pulling out the belt.

Restraint systems

56

Caution!

For safety reasons, avoid adjusting the seat or backrest into positions which could affect the correct seat belt positioning.

Unfastening of seat belts

Push the release button (3) in the belt buckle (2).

Allow the retractor to completely rewind the seat belt by guiding the latch plate (1).

Warning!**USE SEAT BELTS PROPERLY.**

- Each occupant should wear their seat belt at all times, because seat belts help reduce the likelihood of and potential severity of injuries in accidents, including rollovers. The integrated restraint system includes "SRS" (driver airbag, passenger airbag, door mounted side impact airbags), "ETR" (seat belt emergency tensioning retractors), and front seat knee bolsters. The system is designed to enhance the protection offered to properly belted occupants in certain frontal (front airbags) and side (side impact airbags) impacts which exceed preset deployment thresholds.
- Never wear belts over rigid or breakable objects in or on your clothing, such as eyeglasses, pens, keys etc., as these might cause injuries.
- Position the lap belt as low as possible on your hips and not across the abdomen. If the belt is positioned across your abdomen, it can cause serious injuries in a crash.

- Never wear the shoulder belt under your arm, against you neck or off your shoulder. In a crash, your body would move too far forward. That would increase the chance of head and neck injuries. The belt would also apply too much force to the ribs or abdomen, which could severely injure internal organs such as your liver or spleen.
- Each seat belt must never be used for more than one person at a time. Do not fasten a seat belt around a person and another person or other objects.
- Belts should not be worn twisted. In a crash, you wouldn't have the full width of the belt to manage impact forces. The twisted belt against your body could cause injuries.
- Pregnant women should also use a lap-shoulder belt. The lap belt portion should be positioned as low as possible on the hips to avoid pressure on the abdomen.
- Never place your feet on the instrument panel or on the seat. Always keep both feet on the floor in front of the seat.

Warning!

USE CHILD RESTRAINTS PROPERLY.

Children 12 years old and under must never ride in this vehicle, except in a Mercedes-Benz authorized BabySmart™ compatible child seat, which operates with the BabySmart™ system installed in the vehicle to deactivate the passenger side front airbag when it is properly installed. Otherwise they will be struck by the airbag when it inflates in a crash. If this happens, serious or fatal injury will result.

Infants and small children must be seated in an appropriate infant or child restraint system, which is properly secured with the vehicle's seat belt, fully in accordance with the child seat manufacturer's instructions.

A child's risk of serious or fatal injuries is significantly increased if the child restraints are not properly secured in the vehicle and the child is not properly secured in the child restraint.

Adjust the passenger seat as far as possible rearward from the dashboard when the seat is occupied.

BabySmart™ is a trademark of Siemens Automotive Corp.

BabySmart™ airbag deactivation system

Special BabySmart™ compatible child seats, designed for use with the Mercedes-Benz system and available at any authorized Mercedes-Benz Center are required for use with the BabySmart™ airbag deactivation system.

With the special child seat properly installed, the passenger side front airbag will not deploy. The  indicator lamp located in the dashboard will be illuminated, except with key removed or in steering lock position 0. The system does not deactivate the door mounted side impact airbag.

Warning!

The BabySmart™ airbag deactivation system will ONLY work with a special child seat designed to operate with it. It will not work with child seats which are not BabySmart™ compatible.

Never place anything between seat cushion and child seat (e.g. pillow), since it reduces the effectiveness of the deactivation system.

Follow the manufacturer's instructions for installation of special child seats.

The passenger front airbag will not deploy only if the  indicator lamp remains illuminated.

Please be sure to check the indicator every time you use the special system child seat.

Should the light go out while the restraint is installed, please check installation. If the light remains out, do not use the BabySmart™ restraint to transport children on the front passenger seat until the system has been repaired.

Self-test BabySmart™ without special child seat installed

After turning key in steering lock to position 1 or 2, the  indicator lamp located in the dashboard comes on for approx. 6 seconds and then extinguishes.

If the indicator lamp should not come on or is continuously lit, the system is not functioning. You must see an authorized Mercedes-Benz Center before seating any child on the front passenger seat.

BabySmart™ is a trademark of Siemens Automotive Corp.

Supplemental restraint system (SRS)

Airbags are intended as a supplement to seat belts. Airbags alone cannot protect as well as airbags plus seat belts in impacts for which the airbags were designed to operate, and do not afford any protection whatsoever in crashes for which the airbags are not designed to deploy.

The SRS uses two crash severity levels (thresholds) to activate either the emergency tensioning retractor (ETR) or front airbag or both. Activation depends on the direction and severity of the impact exceeding the preset thresholds and whether the seat belt is fastened.

Seat belt fastened

- first threshold exceeded:
ETR activates
- second threshold exceeded:
airbag also activates

Seat belt not fastened

- first threshold exceeded:
airbag activates, but not ETR

Driver and passenger systems operate independently of each other.

Emergency tensioning retractor (ETR)

The seat belts are equipped with emergency tensioning retractors. These tensioning retractors are located in each belt's inertia reel and become operationally ready with the key in steering lock position 1 or 2.

The emergency tensioning retractors are designed to activate only when the seat belts are fastened during frontal and front-angled impacts and rear impacts exceeding the first threshold of the SRS and in rear impacts exceeding a preset severity level. They remove slack from the belts in such a way that the seat belts fit more snugly against the body restricting its forward movement as much as possible.

In cases of other frontal impacts, rollovers, certain side impacts, rear collisions or other accidents without sufficient frontal or rear impact forces, the emergency tensioning retractors will not be activated. The driver and passenger will then be protected by the fastened seat belts and inertia reel in the usual manner.

For seat belt and emergency tensioning retractor safety guidelines see page 66.

Restraint systems

60

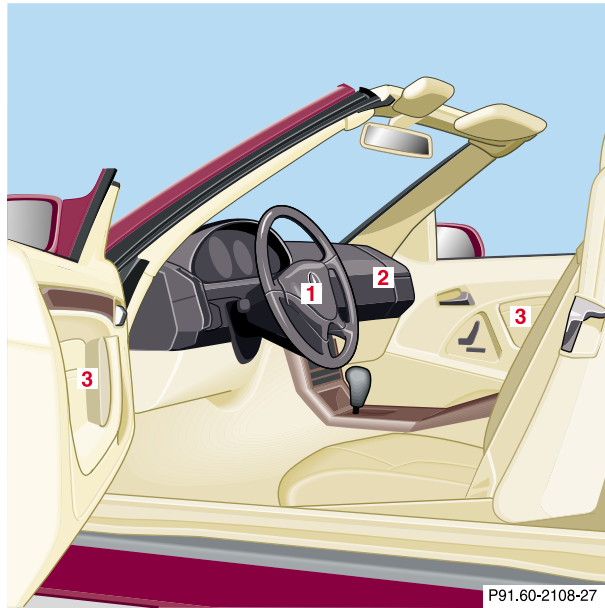
Airbags

- 1 Driver airbag
- 2 Passenger front airbag
- 3 Side impact airbags

The most effective occupant restraint system yet developed for use in production vehicles is the seat belt. In some cases, however, the protective effect of a seat belt can be further enhanced by an airbag.

In conjunction with wearing the seat belts, the driver and passenger airbags can provide increased protection for the driver and passenger in certain frontal impacts exceeding preset thresholds. Door mounted side impact airbags can provide increased protection to belted occupants on the impacted side of the vehicle in side impacts exceeding its preset thresholds.

The operational readiness of the airbag system is verified by the indicator lamp "SRS" in the instrument cluster when turning the key in steering lock to position 2. If no fault is detected, the lamp will go out after approximately 4 seconds: after the lamp goes out, the system continues to monitor the components and circuitry of the airbag system and will indicate a malfunction by coming on again. If the lamp does not

come on at all or if it fails to extinguish after approximately 4 seconds or if it comes on thereafter, a malfunction in the system has been detected.

The following system components are monitored or undergo a selfcheck: crash-sensor(s), airbag ignition circuits, seat belt buckles, emergency tensioning retractors, seat sensor.

Initially, when the key is turned from steering lock position 0 to positions 1 or 2, malfunctions in the crash-sensor are detected and indicated (the “SRS” indicator lamp stays on longer than 4 seconds or does not come on). In the operational mode, after the indicator lamp has gone out following the initial check, interruptions or short circuits in the airbag ignition circuit and in the driver and passenger seat belt buckle harnesses, and low voltage in the entire system are detected and indicated.

Have the system checked at your authorized Mercedes-Benz Center immediately.

Warning!

In the event a malfunction of the “SRS” is indicated as outlined above, the “SRS” may not be operational. For your safety, we strongly recommend that you visit an authorized Mercedes-Benz Center immediately to have the system checked; otherwise the “SRS” may not be activated when needed in an accident, which could result in serious or fatal injury, or it might deploy unexpectedly and unnecessary which could also result in injury.

Restraint systems

62

Front airbags

The driver and passenger front airbags are designed to activate only in certain frontal impacts exceeding a preset threshold.

The passenger front airbag deploys only if the front passenger seat is occupied, and the  indicator lamp in the dashboard is not illuminated.

Note:

Heavy objects on the passenger seat can appear to the “SRS” to indicate the presence of an occupant in that seat which causes the passenger front airbag to deploy in a crash exceeding the appropriate threshold.

Side impact airbags

The side impact airbags are designed to activate only in certain side impacts exceeding a preset threshold. Only the side impact airbag on the impacted side of the vehicle deploy.

The passenger side impact airbag deploys only if the passenger seat is occupied.

Side impact airbags operate best in conjunction with a properly positioned and fastened seat belt.

Note:

Heavy objects on passenger seat can cause the passenger door side impact airbag to deploy in a crash.

Important!

Airbags are designed to activate only in certain frontal (front airbags) impacts, or side (side impact airbags) impacts which exceed preset thresholds.

Only during these types of impacts, if of sufficient severity to meet the deployment thresholds, will they provide their supplemental protection.

The driver and passenger must always wear their seat belts, otherwise it is not possible for the airbags to provide their intended supplemental protection.

In cases of other frontal impacts, angled impacts, roll-overs, other side impacts, rear collisions, or other accidents in which the airbags are not designed to deploy, the airbags will not be activated. The driver and passenger will then be protected by the fastened seat belts.

We caution you not to rely on the presence of the airbags in order to avoid wearing your seat belt.

Your vehicle was originally equipped with airbags which are designed to activate in certain impacts exceeding a preset threshold to reduce the potential and severity of injury. It is important to your safety and that of your passenger that you replace deployed airbags and repair any malfunctioning airbags to ensure the vehicle will continue to provide crash protections for occupants.

Warning!

Airbags are designed to reduce the potential of injury in certain frontal (front airbags) impacts, and side (side impact airbags) impacts which may cause significant injuries, however, no system available today can totally eliminate injuries and fatalities.

The activation of the “SRS” temporarily releases a small amount of dust from the airbags. This dust, however, is neither injurious to your health, nor does it indicate a fire in the vehicle. The dust might cause some temporary breathing difficulty for people with asthma or other breathing trouble. To avoid this, you may wish to get out of the vehicle as soon as it is safe to do so. If you have any breathing difficulty but cannot get out of the vehicle after the airbag inflates, then get fresh air by opening a window or door.

The service life of the airbags extends to the date indicated on the label located on the driverside door latch post. To provide continued reliability after that date, they should be inspected by an authorized Mercedes-Benz Center at that time and replaced when necessary.

To reduce the risk of injury when the front airbags inflate, it is very important for the driver and front passenger to always be in a properly seated position and to wear your seat belt.

For maximum protection in the event of a collision always be in normal seated position with your back against the backrest. Fasten your seat belt and ensure that it is properly positioned on your body.

For unobstructive inflation of door side impact airbags, keep door pocket lids closed.

Since the airbag inflates with considerable speed and force, a proper seating and hands on steering wheel position will help to keep you at a safe distance from the airbag.

Occupants who are unbelted, out of position or too close to the airbag can be seriously injured by an airbag as it inflates with great force in the blink of an eye:

- Sit properly belted in an upright position with your back against the backrest.

- Adjust the driver seat as far as possible rearward, still permitting proper operation of vehicle controls. Adjust the driver seat as far as possible rearward, still permitting proper operation of vehicle controls. The distance from the center of the driver's breastbone to the center of the airbag cover on the steering wheel must be at least ten inches (25 cm) or more. You should be able to accomplish this by a combination of adjustments to the seat and steering wheel. If you have any problems, please see your authorized Mercedes-Benz Center.
- Do not lean with your head or chest close to the steering wheel or dashboard.
- Keep hands on the outside of steering wheel rim. Placing hands and arms inside the rim can increase the risk and potential severity of hand/arm injury when the driver front airbag inflates.
- Do not lean against doors.

- **Occupants, especially children, should never lean their heads in the area of the door where the side airbag inflates. This could result in serious injuries or death should the airbag be triggered.**
- **Adjust the passenger seat as far as possible rearward from the dashboard when the seat is occupied.**
- **Children 12 years old and under must never ride in this vehicle, except in a Mercedes-Benz authorized BabySmart™ compatible child seat, which operates with the BabySmart™ system installed in the vehicle to deactivate the passenger front airbag when it is properly installed. Otherwise they will be struck by the airbag when it inflates in a crash. If this happens, serious or fatal injury can result.**

Failure to follow these instructions can result in severe or fatal injuries to you or other occupants.

BabySmart™ is a trademark of Siemens Automotive Corp.

Safety guidelines for the seat belt, emergency tensioning retractor and airbag

Warning!

- Damaged seat belts or belts that were highly stressed in an accident must be replaced and their anchoring points must also be checked. Use only belts installed or supplied by an authorized Mercedes-Benz Center.
- Do not pass belts over sharp edges.
- Do not make any modification that could change the effectiveness of the belts.
- Airbags and ETR's are designed to function on a one-time-only basis. An airbag or emergency tensioning retractor (ETR) that was activated must be replaced.

- No modifications of any kind may be made to any components or wiring of the "SRS". This includes changing or removing any component or part of the "SRS", the installation of additional trim material, badges etc. over the steering wheel hub, passenger airbag cover, or door trim panels, and installation of additional electrical/electronic equipment on or near "SRS" components and wiring. Keep area between airbags and occupants free of objects (e.g. packages, purses, umbrellas, etc.).
- An airbag system component within the steering wheel gets hot after the airbag has inflated. Do not touch.
- Improper work on the system, including incorrect installation and removal, can lead to possible injury through an unintended activation of the "SRS".
- In addition, through improper work there is the risk of rendering the "SRS" inoperative or causing unintended airbag deployment. Work on the "SRS" must therefore only be performed by an authorized Mercedes-Benz Center.

- **For your protection and the protection of others, when scrapping the airbag unit or emergency tensioning retractor, our safety instructions must be followed. These instructions are available at your authorized Mercedes-Benz Center.**
- **Given the considerable deployment speed and the textile structure of the airbags, there is the possibility abrasions or other injuries resulting from airbag deployment.**

When you sell the vehicle we strongly urge you to give notice to the subsequent owner that it is equipped with an “SRS” by alerting him to the applicable section in the Operator’s Manual.

Infant and child restraint systems

Use only a BabySmart™ compatible child restraint in this vehicle.

We recommend that all infants and children be properly restrained at all times while the vehicle is in motion.

The passenger lap-shoulder belt has a special seat belt retractor for secure fastening of a child restraint.

To fasten a child restraint follow child restraint instructions for routing. Then pull shoulder belt out completely. Slide switch located on side of passenger seat to position . Let the belt retract. During the seat belt retraction a ratcheting sound can be heard to indicate that the special seat belt retractor is activated. The belt is now locked. Push down on child restraint to take up any slack.

To deactivate, release seat belt buckle and let seat belt retract completely. The seat belt can again be used in the usual manner.

Warning!

Never release the seat belt buckle while vehicle is in motion, since the special seat belt retractor will be deactivated.

Restraint systems

68

Important!

The use of infant or child restraints is required by law in all 50 states and all Canadian provinces.

Infants and small children should be seated in an appropriate infant or child restraint system properly secured by a lap-shoulder belt, and that complies with U.S. Federal Motor Vehicle Safety Standard 213 and Canadian Motor Vehicle Safety Standard 213.

A statement by the child restraint manufacturer of compliance with this standard can be found on the instruction label on the restraint and in the instruction manual provided with the restraint.

When using any infant or child restraint system, be sure to carefully read and follow all manufacturer's instructions for installation and use.

Please read and observe warning labels affixed to inside of vehicle and to infant or child restraints.

Warning!

Children 12 years old and under must never ride in this vehicle, except in a Mercedes-Benz authorized BabySmart™ compatible child seat, which operates with the BabySmart™ system installed in the vehicle to deactivate the passenger front airbag when it is properly installed. Otherwise they will be struck by the airbag when it inflates in a crash. If this happens, serious or fatal injury can result.

Infants and small children must be seated in an appropriate infant or child restraint system, which is properly secured with the vehicle's seat belt, fully in accordance with the child seat manufacturer's instructions.

Infants and small children should never share a seat belt with another occupant. During an accident, they could be crushed between the occupant and seat belt.

When the child restraint is not in use, remove it from the vehicle or secure it with the seat belt to prevent the child restraint from becoming a projectile in the event of an accident.

U.S.A. Models only

Since 1986 all U.S. child restraints comply with U.S. regulations without the use of a tether strap.

BabySmart™ is a trademark of Siemens Automotive Corp.

Adjusting steering column

70

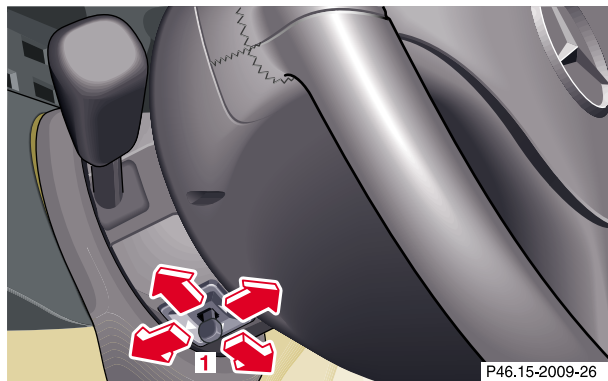
Adjusting steering column

Turn key in steering lock to position 1 or 2 (with either door open, the steering column can be operated with the key removed or in steering lock position 0).

To extend or retract:

Move switch (1) in desired direction.

To raise or lower:

Move switch (1) in desired direction.

Storing steering column position in memory

The steering column position is stored in memory together with the seat/heat restraint/exterior rear view mirror position and can be recalled when necessary, see memory recalling on page 46.

Warning!

Do not adjust the steering wheel while driving. Adjusting the steering wheel while driving, or driving without the telescoping adjustment locked could cause the driver to lose control of the vehicle.

Rear view mirrors

Inside rear view mirror

Manually adjust the mirror.

Use your inside mirror to determine the size and distance of objects seen in the passenger side convex mirror.

Antiglare night position

With the key in steering lock position 2, the mirror reflection brightness responds to changes in light sensitivity.

With gear selector lever in position “R”, or with the interior lamp switched on, the mirror brightness does not respond to changes in light sensitivity.

Note:

The automatic antiglare function does not react, if incoming light is not aimed directly at sensors in the mirror.

Warning!

In the case of an accident liquid electrolyte may escape the mirror housing when the mirror glass breaks.

Electrolyte has an irritating effect. Do not allow the liquid come into contact with eyes, skin, clothing, or respiratory system. In cases it does, immediately flush affected area with water, and seek medical help if necessary.

Rear view mirrors

72

Exterior rear view mirrors

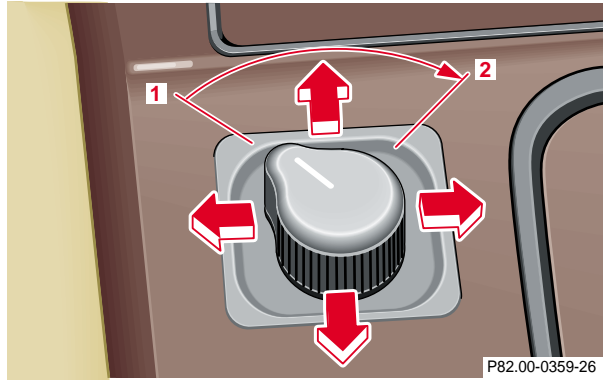

The switch is located on the center console.

Turn key in steering lock to position 2.

First select the mirror to be adjusted - turn switch:

- 1 Left mirror
- 2 Right mirror

To adjust, toggle the switch forward, backward or to either side.

With the key in steering lock position 2, the driver's side mirror reflection brightness responds to changes in light sensitivity.

With gear selector lever in position "R", or with the interior lamp switched on, the driver's side mirror brightness does not respond to changes in light sensitivity.

Warning!

Exercise care when using the passenger-side mirror. The passenger-side exterior mirror is convex (outwardly curved surface for a wider field of view). Objects in mirror are closer than they appear. Check your inside rear view mirror or glance over your shoulder before changing lanes.

Notes:

The exterior mirrors have electrically heated glass. The heater switches on automatically, depending on outside temperature.

If the mirror housing is forcibly pivoted from its normal position, it must be repositioned by applying firm pressure until it snaps into place.

Warning!

In the case of an accident liquid electrolyte may escape the mirror housing when the mirror glass breaks.

Electrolyte has an irritating effect. Do not allow the liquid come into contact with eyes, skin, clothing, or respiratory system. In cases it does, immediately flush affected area with water, and seek medical help if necessary.

Important!

Electrolyte drops coming into contact with the vehicle paint finish can only be completely removed while in their liquid state, by applying plenty of water.

Storing mirror positions in memory

The exterior rear view mirror positions are stored in memory with the seat/head restraint/steering column position and can be recalled when necessary, see memory recalling on page 46.

Instrument cluster

Instrument cluster



- 1** Fuel gauge with reserve and fuel cap placement warning lamp (yellow), see page 207
- 2** Coolant temperature gauge, see page 78
- 3** Fuel consumption gauge, see page 83
- 4** Engine oil temperature gauge, see page 83
- 5** Left turn signal indicator lamp (green), see combination switch on page 86
- 6** Knob for intensity of instrument lamps, see page 77, for resetting trip odometer, see page 79 and for calling up FSS indicator, see page 80
- 7** Speedometer
- 8** EPS warning lamp (yellow), see page 207
- 9** Odometer display field, see page 82
- 10** Main/trip odometer, see page 79 or FSS indicator, see page 80 or engine oil level indicator, see page 82
- 11** Outside temperature indicator, see page 78
- 12** Right turn signal indicator lamp (green), see combination switch on page 86
- 13** Tachometer, see page 79
- 14** Knob for setting clock, see page 79
- 15** Clock, see page 79

Instrument cluster

76

Indicator lamps in the instrument cluster

Fuel reserve and fuel cap placement warning, see page 207



High beam, see page 86



Battery not being charged properly, see page 211



Low windshield and headlamp washer system fluid level see page 210



Coolant level low, see page 209



Engine oil level low, see page 210



Exterior lamp failure indicator lamp, see page 211



Roll bar warning lamp, see page 212



ESP warning lamp. Adjust driving to road condition, see page 207



ADS indicator lamp, see page 212



BAS/ESP malfunction, see page 207



ABS malfunction, see page 208



Brake pads worn down, see page 205



Brake fluid low (except Canada)
Parking brake engaged, see page 204



Brake fluid low (Canada only)
Parking brake engaged, see page 204



SRS malfunction, see page 206



Fasten seat belt, see page 206



If the lamp comes on when the engine is running, it indicates a malfunction of the fuel management system or the emission control system, or the fuel cap is not closed tight. In all cases, we recommend that you have the malfunction checked as soon as possible, see page 204.

Additional function indicator lamps (in the odometer display)



FSS indicator (distance, Service A), see page 80.



FSS indicator (distance, Service B), see page 80.



FSS indicator (days, Service A), see page 80.



FSS indicator (days, Service B), see page 80.



Start lock-out malfunction, see page 34.

Instrument lamps



1 Adjusting knob

Rotate adjusting knob (1) to vary intensity of instrument lamps.

Display illumination

Press adjusting knob (1) to briefly illuminate the display (with key removed or in steering lock position 0 or 1).

Coolant temperature gauge

During severe operating conditions and stop-and-go city traffic, the coolant temperature may rise close to the red marking.

The engine should not be operated with the coolant temperature in the red zone. Doing so may cause serious engine damage which is not covered by the Mercedes-Benz Limited Warranty.

Warning!

- **Driving when your engine is badly overheated can cause some fluids which may have leaked into the engine compartment to catch fire. You could be seriously burned.**
- **Steam from an overheated engine can cause serious burns and can occur just by opening the engine hood. Stay away from the engine if you see or hear steam coming from it.**

Turn off the engine, get out of the vehicle and do not stand near the vehicle until it cools down.

Outside temperature indicator

The temperature sensor is located in the front bumper area. Due to its location, the sensor can be affected by road or engine heat during idling or slow driving. This means that the accuracy of the displayed temperature can only be verified by comparison to a thermometer placed next to the sensor, not by comparison to external displays (e.g. bank signs etc.).

Adaptation to ambient temperature takes place in steps and depends on the prevailing driving conditions (stop-and-go or moderate, constant driving) and amount of temperature change.

Warning!

The outside temperature indicator is not designed to serve as an Ice-Warning Device and is therefore unsuitable for that purpose. Indicated temperatures just above the freezing point do not guarantee that the road surface is free of ice.

Trip odometer



To reset:

- Press adjusting knob (1) once (with key in steering lock position 2).
- Press adjusting knob (1) twice (with key removed or in steering lock position 0 or 1).

Clock

Adjusting clock one minute ahead or back:

Pull out adjustment knob (2), briefly turn to the right respectively left and release knob.

Adjusting clock more than one minute ahead or back:

Pull out adjustment knob (2), turn to the right respectively left and hold until the desired time is set. Within the first 2 seconds, the minute hand advances 8 minutes and advances another 8 minutes every additional second thereafter.

Tachometer

The red marking on the tachometer denotes excessive engine speed.

Avoid this engine speed, as it may result in serious engine damage that is not covered by the Mercedes-Benz Limited Warranty.

To help protect the engine, the fuel supply is interrupted if the engine is operated within the red marking.

Flexible service system

**Flexible service system (FSS)
(service indicator)**



The FSS permits a flexible service schedule that is directly related to the operating conditions of the vehicle.

The symbol  or  appears in the main odometer display field prior to the next suggested service.

Depending on operating conditions throughout the year, the next service is calculated and displayed in days

 or distance  remaining.



80

The symbols  or  indicate the type of service to be performed:

 Service A

 Service B

The message is displayed for approximately 10 seconds when turning the key in steering lock to position 2, or while driving when reaching the service warning threshold. It can be canceled manually by pressing button (1).

Once the suggested term has passed, the message plus symbol  or , preceded by a - (minus symbol) blinks for approx. 30 seconds and a signal sounds every time when turning the key in steering lock to position 2.

The FSS display can also be called up for approx. 10 seconds with display illuminated by pressing button (1) twice within 1 second.

Following a completed

A or B service the Mercedes-Benz Center sets the counter to 10 000 miles (Canada: 15 000 km) and 365 days.

The counter can also be set by any individual. To do so:

1. Turn key in steering lock to position 2.
2. Within 4 seconds press button (1) twice.
3. The present status for days or distance is displayed. Within 10 seconds turn key in steering lock to position 0.
4. Press and hold button (1), while turning key in steering lock to position 2 again. The present status for days or distance is displayed once more. Continue to hold button (1).

After approx. 10 seconds a signal sounds, and the display shows 10 000 miles (Canada: 15 000 km) for approx. 10 seconds.

5. Release button (1).

If the FSS counter was inadvertently reset, have a Mercedes-Benz Center correct it.

Note:

When disconnecting vehicle battery for one or more days at a time, such days will not be counted. Any such days not counted by FSS can be added by your Mercedes-Benz Center.

The interval between services is determined by the kind of vehicle operation. For example driving at extreme speeds, and cold starts combined with short distance driving in which the engine does not reach normal operating temperature, reduce the interval between services.

Model SL 500

The FSS allows for distances between 10 000 miles (Canada: 15 000 km) and 20 000 miles (Canada: 30 000 km), or from 365 to 730 days between services.



Model SL 600

The FSS allows for distances between 10 000 miles (Canada: 15 000 km) and 16 000 miles (Canada: 25 000 km), or from 365 to 730 days between services.

However you choose to set your reference numbers, the scheduled services as posted in the Service Booklet must be followed to properly care for your vehicle.

Checking engine oil level indicator

Engine oil level indicator in odometer display field
(Model SL 500)

Turn electronic key in steering lock to position 2 and wait until the symbols  and  appear in the odometer display field.

Within 1 second press button “1” twice.

82

The following messages are available:

“OK”

“-1.0 Q” (Canada: -1.0 L)

“-1.5 Q” (Canada: -1.5 L)

“-2.0 Q” (Canada: -2.0 L)

If the message “-2.0 Q” (Canada: -2.0 L) blinks and a signal sounds, add oil to upper (max) mark of the dipstick.

“HI”

The message “HI” blinks and a signal sounds.

Do not overfill the engine.

Excessive oil must be drained or siphoned. It could cause damage to engine and catalytic converter not covered by the Mercedes-Benz Limited Warranty.



The symbol  flashes in the odometer display field if a proper oil level check cannot be performed.

The oil level check can be repeated after a short time.

Perform the oil level check with the dipstick, if it cannot be completed via the odometer display field.

In this case we recommend that you have the system checked at a Mercedes-Benz Center.

Notes:

If the symbols  and  are continuously illuminated after pressing button (1) twice and there is no change in the odometer display field or the low engine oil level warning lamp comes on, a malfunction has occurred to the system. Perform the engine oil level check with the dipstick.

If no oil leaks are noted continue to drive to the nearest Mercedes-Benz Center to have the system checked.

Observe the engine oil temperature gauge.

Fuel consumption gauge

While driving, instantaneous fuel consumption is indicated in miles per gallon (mpg), or in Canada liters per 100 kilometers (l/100 km).

With the engine switched off, the needle reads “0”.

Due to system design, minimum consumption is indicated at idle speed.

Engine oil temperature gauge

Normal operating engine oil temperatures are from 175 F (80 C) to 250 F (120 C).

During severe operating conditions and stop-and-go traffic, the engine oil temperature may rise close to the red marking.

The engine should not be operated with the engine oil temperature in the red zone. Doing so may cause serious engine damage which is not covered by the Mercedes-Benz Limited Warranty.

When the engine oil temperature is close to the red marking, relieve the load on the engine by decreasing vehicle speed to lower engine oil temperature.

Once the engine oil temperature returns to the normal temperature range, the engine oil level should be checked. See page 82 or 221.





Engine oil consumption

Engine oil consumption checks should only be made after the break-in period. During the break-in period, higher oil consumption may be noticed and is normal. Frequent driving at high engine speeds results in increased consumption.



Exterior lamp switch

Exterior lamp switch



-  Off
-  Parking lamps (also side marker lamps, taillamps, licence plate lamps, instrument panel lamps)
Canada only: When the engine is running, the low beam is additionally switched on.
-  Parking lamps plus low beam or high beam headlamps (combination switch pushed forward).
-  Standing lamps, right (turn left one stop)
-  Standing lamps, left (turn left two stops)

84

-  Front fog lamps (pull out one stop) with parking lamps and/or low beam headlamps on. Green indicator in lamp switch comes on.
-  Rear fog lamp (pull out to second detent) in addition to the front fog lamps. Yellow indicator in lamp switch comes on.

Note:

With the key removed and a door open, a warning sounds if the vehicle's exterior lamps (except standing lamps) are not switched off.

Fog lamps will operate with the parking lamps and/or the low beam headlamps on. Fog lamps should only be used in conjunction with low beam headlamps. Consult your State or Province Motor Vehicle Regulations regarding allowable lamp operation.

Fog lamps are automatically switched off when the exterior lamp switch is turned to position .

Standing lamps

When the vehicle is parked on the street the standing lamps (right or left side parking lamps) can be turned on, making the vehicle more visible to passing vehicles.

The standing lamps cannot be operated with the key in steering lock position 2.

Daytime running lamp mode

When the engine is running and the selector lever is in a driving position, the low beam headlamps (includes parking lamps, side marker lamps, taillamps and license plate lamps) are automatically switched on.

When shifting from a driving position to position “N” or “P”, the low beam switches off (2 seconds delay).

For nighttime driving the exterior lamp switch should be turned to position  to permit activation of the high beam headlamps.



Night security illumination

When exiting the vehicle after driving with the exterior lamps on, they switch on again for added illumination for approximately 30 seconds after closing the last door. The lamp-on time period can be changed at your Mercedes-Benz Center.

Combination switch

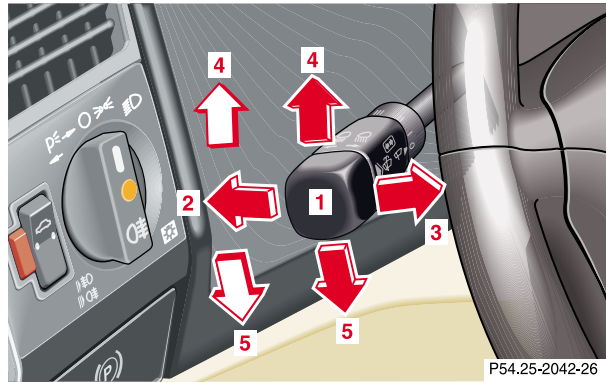
Combination switch



- 1 Low beam (exterior lamp switch position )
- 2 High beam (exterior lamp switch position )
- 3 High beam flasher (high beam available independent of exterior lamp switch position)
- 4 Turn signals, right
- 5 Turn signals, left

86

To signal minor directional changes, such as changing lanes on a highway, move combination switch to the point of resistance only and hold it there.

To operate the turn signals continuously, move the combination switch past the point of resistance (up or down). The switch is automatically canceled when the steering wheel is turned to a large enough degree.

Turn signal failure

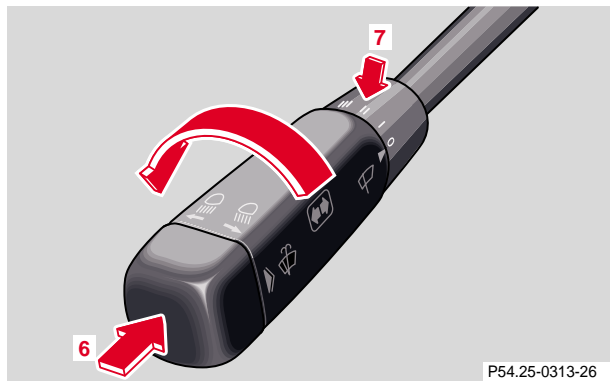

If one of the turn signal lamps fails, the turn signal indicator system flashes and sounds at a faster than normal rate.



P54.25-0313-26

6 Press switch briefly:

One wipe without washer water
(select only if windshield is wet).

Press switch past resistance point:
Windshield washer, windshield wiper;
headlamp cleaning system only in exterior lamp
switch positions  or  (except xenon
lamps).

Canada only: also in position  when the engine
is running.

7 Windshield wiper

0 Wiper off

I Intermittent wiping

One initial wipe, pauses between wipes are
automatically controlled by a rain sensor
monitoring the wetness of the windshield.

Notes:

With switch in this position, one wipe occurs
when turning the key in steering lock from
position 0.

Do not leave in intermittent setting when vehicle
is taken to an automatic car wash or during
windshield cleaning. Wiper will operate in
presence of water spray at windshield, and wiper
may be damaged as a result.

II Normal wiper speed

III Fast wiper speed

Note:

The windshield washer reservoir, hoses and nozzles are
automatically heated.

Combination switch

88

Blocked windshield wiper

If the windshield wiper becomes blocked (for example, due to snow), switch off the wiper.

For safety reasons before removing ice or snow, remove key from steering lock. Remove blockage.

Activate combination switch again (key in steering lock position 1).

Windshield wiper smears

If the windshield wiper smears the windshield, even during rain, activate the washer system as often as necessary. The fluid in the washer reservoir should be mixed in the correct ratio.

Windshield and headlamp washer fluid mixing ratio

For temperatures above freezing:

MB Windshield Washer Concentrate "S" and water

1 part "S" to 100 parts water

(40 ml "S" to 1 gallon water).

For temperature below freezing:

MB Windshield Washer Concentrate "S" and commercially available premixed windshield washer solvent/antifreeze

1 part "S" to 100 parts solvent

(40 ml "S" to 1 gallon solvent).

Hazard warning flasher switch

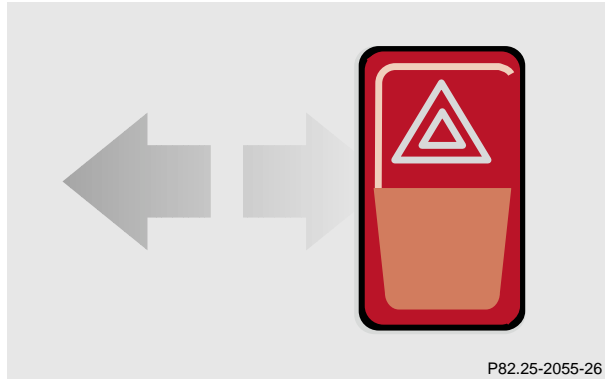

The hazard warning flasher can be activated manually via the switch located in the dashboard.

To activate hazard warning flasher, press switch once. To deactivate, press switch again.

Note:

With the hazard warning flasher activated, and the combination switch in position for either left or right turn with key in steering lock position 2, only the respective left or right side turn signals will operate.

Automatic climate control

Automatic climate control

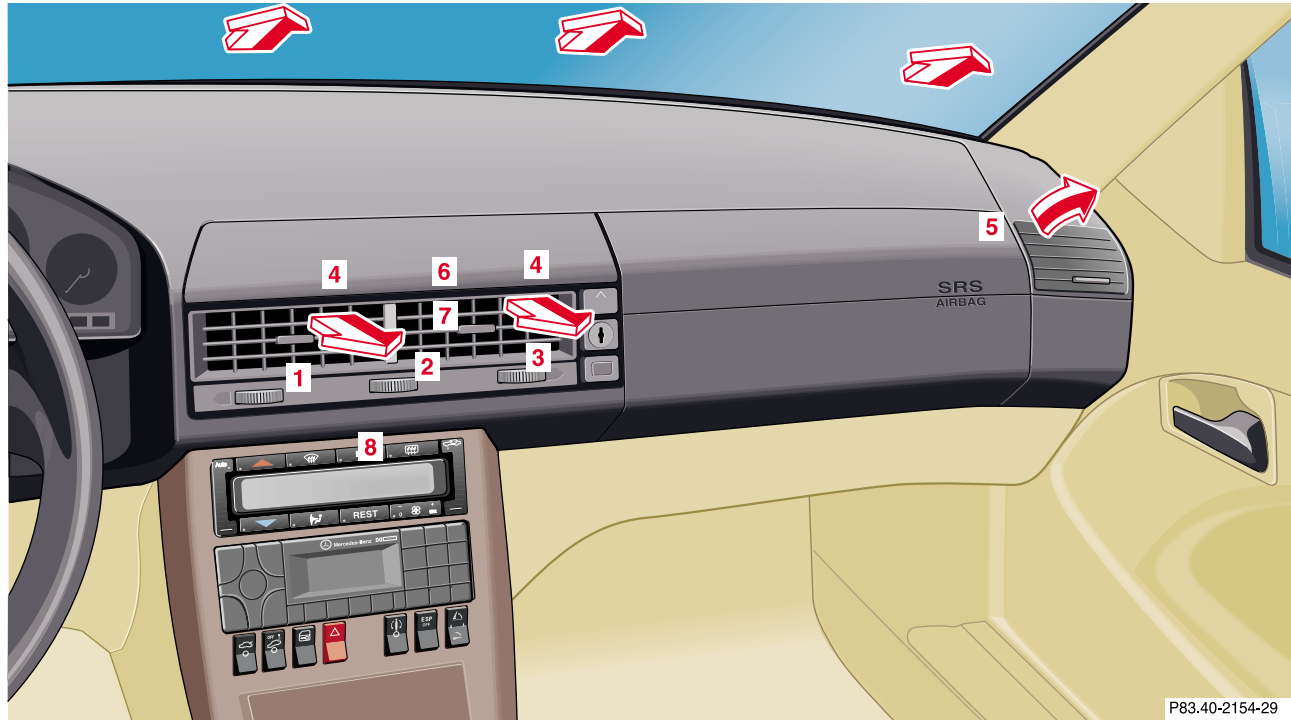

- 1 Air volume control for left air outlet, turn left to open.
- 2 Air volume control for center air outlets, turn left to open.
- 3 Air volume control for right air outlet, turn left to open.
- 4 Center air outlets, adjustable
- 5 Side air outlet, left and right, adjustable

Push-buttons for center air outlets

- 6 Heated air supply
 - 7 Non-heated/cooled air supply
- Basic mode:
None of the push-buttons (6 or 7) is pressed.
- 8 Display and controls, see page 92

The system is always at operational readiness, except when manually switched off.

The automatic climate control only operates with the engine running.

The temperature selector should be left at the desired temperature setting. The temperature selected is reached as quickly as possible.

The system will not heat or cool any quicker by setting a higher or lower temperature.

The automatic climate control removes considerable moisture from the air during operation in the cooling mode. It is normal for water to drip on the ground through ducts in the underbody.

Important!

This vehicle is equipped with an air conditioner system that uses R-134a (HFC: hydrofluorocarbon) as a refrigerant. Repairs should always be performed by a qualified technician, and refrigerant should be collected in a recovery system for recycling.

Automatic climate control

92

Display and controls

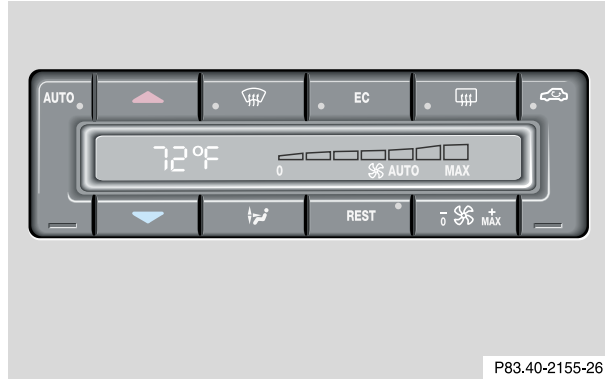



Press the desired button to activate, indicator lamp is on while activated.

- AUTO** Automatic mode
- ▲** Raise temperature
- ▼** Lower temperature
- ☀** Defrost
- 🚗** Air recirculation
- 🚗** Rear window defroster
- 🚗** Air distribution, manual
- EC** Economy mode
- 🌀** Air volume, manual
- REST** Residual engine heat utilization

Basic setting - automatic mode

Press **AUTO** button for automatic mode.

Simultaneously press both  and  buttons for temperature setting of 72°F.

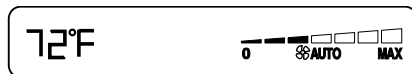

Air volume and distribution are controlled automatically.

This setting can be used all year around.

Economy

The function of this setting corresponds to the automatic mode. However, because the air conditioning compressor will not engage (fuel savings), it is not possible to air condition in this setting.

Press **EC** button to activate.

Press **EC** button once again to return to previous setting.

Automatic climate control

Special settings (use only for short duration)**Defogging windows**

Switch off  button.

Press **AUTO** button.

Press  button repeatedly until air is directed upward.

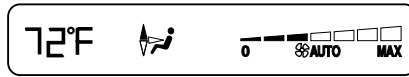

Turn wheels (1 and 3) left to open left and right side air outlets (5).

94

Defrosting

Turn wheels (1 and 3) left to open left and right side air outlets (5).

Press  button. Maximum heated and automatically controlled amount of air is directed to the windshield and side windows.



Press  button once again to return to previous setting.

Rear window defroster

(only functions with hardtop installed)

Turn electronic key in steering lock to position 2.

To select, press  button.

To cancel, press  button again.

Note:

Heavy accumulation of snow and ice should be removed before activating the defroster.

The rear window defroster uses a large amount of power. To keep the battery drain to a minimum, turn off the defroster as soon as the window is clear.

The defroster is automatically turned off after a maximum of 12 minutes of operation.

If several power consumers are turned on simultaneously, or the battery is only partially charged, it is possible that the defroster will automatically turn itself off. When this happens, the indicator lamp inside the switch starts blinking.

As soon as the battery has sufficient voltage, the defroster automatically turns itself back on.

Air distribution



Press  button repeatedly until the requested symbol is displayed.

Air volume

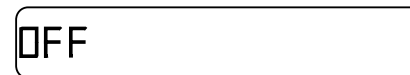

Press “-” or “+” side of rocker switch  until the requested blower speed is attained. A choice of 7 blower speeds is available.

To switch the automatic climate control off, press “-” side of rocker switch  until symbol OFF is displayed.



The fresh air supply to the car interior is shut off.

While driving, use this setting only temporarily, otherwise the windshield could fog up.

To switch the automatic climate control on again, press , , or “+” side of .

Automatic climate control

Air recirculation

This mode can be selected to temporarily reduce the entry of annoying odors or dust into the vehicle's interior.

Outside air is not supplied to the car's interior.

To select, press  button.

To cancel, press  button again.

The system will automatically switch from recirculated air to fresh air

- after approx. 5 minutes at outside temperatures below approx. 40°F (5°C),
- after approx. 30 minutes, at outside temperatures above approx. 40°F (5°C),
- after approx. 5 minutes, if button **EC** is pressed.

Notes:

If the windows should fog up from the inside, switch from recirculated air back to fresh air.

At high outside temperatures, the system automatically engages the recirculated air mode thereby increasing the cooling capacity performance, switching to partially fresh air within 20 minutes.

96

Residual engine heat utilization

With the engine switched off, it is possible to continue heating the interior for a short while.

Air volume and distribution are controlled automatically.

To select:

Turn electronic key in steering lock to position 1 or 0 or remove electronic key.

Press **REST** button.

This function selection will not activate if the battery charge level is insufficient.

To cancel:

Press **REST** button.

The system will automatically shut off

- If you turn electronic key in steering lock to position 2,
- after approx. 30 minutes,
- if the battery voltage drops.

Dust filter

Nearly all dust particles and pollen are filtered out before outside air enters the passenger compartment through the air distribution system.

Notes:

Do not obstruct the air flow by placing objects on the air flow through exhaust slots below the rear window.

Also keep the air intake grille in front of windshield free of snow and debris.

Audio and telephone, operation

These instructions are intended to help you become acquainted with your Mercedes-Benz vehicle radio. They contain useful tips and a detailed description of the user functions.

Warning!

In order to avoid distraction which could lead to an accident, system settings should be entered with the vehicle at standstill and systems should be operated by the driver only when traffic conditions permit. Always pay full attention to traffic conditions first before operating system controls while driving.

Bear in mind that at a speed of just 30 mph (approximately 50 km/h), your vehicle is covering a distance of approximately 50 feet (approximately 14 m) every second.

The right to correct errors and make technical amendments is reserved.

Operating safety

Warning!

Any alternations made to electronic components can cause malfunctions

The radio, cassette deck, CD changer ¹ and telephone ¹ are interconnected. Therefore, when one of the components is defective or has not been removed/replaced properly this may impair the function of other components.

These malfunctions might seriously impair the operating safety of your vehicle.

We recommend that you have any service work or alternations on electronic components done in an authorized Mercedes-Benz Center.

1 Optional equipment

Dolby and the double-D symbol  are trademarks of Dolby Laboratories Licensing Corporation. The Dolby noise reduction system is manufactured under licence from Dolby Laboratories Licensing Corporation.

Operating and display elements



- 1 On/off, volume, see page 102
- 2 Telephone mode selector, see page 113
- 3 Seek, see page 104, 107 and 111
- 4 Radio mode selector, see page 104
- 5 Tune, see page 104 and 105
Fast Forward/Reverse, see page 108 and 111
- 6 CD mode selector, see page 110
- 7 Display panel, see page 106
- 8 Alpha-numeric keypad for station storage and frequency entry, see page 105
optional telephone, see page 113
Tape eject, see page 107
Tape track select, see page 107
Dolby, see page 108
CD Random/repeat, see page 112
- 9 Function button, see page 105 and 112

Audio system

100

- 10 Soft keys for
radio band selection, see page 104
tone controls, see page 102
scan, see page 105
- 11 Tape mode selector, see page 106

Anti-theft system

CODE

If the power supply to the radio has been interrupted, "CODE" will appear on the display when it is next switched on. The radio

will only work after the five-digit code has been entered using the buttons on the right-hand control panel.

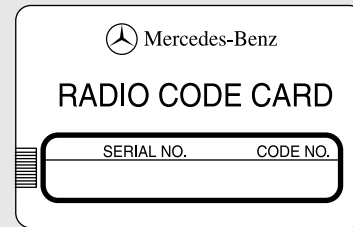

P82.60-2138-26

The code number is shown on the Radio code card, supplied with the radio.

Important!

Never leave the Radio code card in the vehicle. Keep it in a safe place.

Entering the code number

Switch on the radio. "CODE" will appear on the display. Using the buttons on the alpha-numeric keypad, enter the five digit code. Confirm by pressing the "OK" key.

If an incorrect code has been entered and confirmed, "CODE" will reappear on the display. The correct code must be entered once again.



WAIT

If an incorrect code is entered three times, "WAIT" will appear on the display and the radio will be locked out for about 10 minutes.

Note:

The lock out time will only count down if the radio is left switched on.

Button and soft key operation

In these instructions, the alpha-numeric keypad (right side of radio face) and the function buttons (left side of the radio face) are referred to as "buttons" and the four keys under the display are referred to as "soft keys"

Note:

Do not press directly on the radio display face.

Audio system

102

Operation**Switching on and off**

Press the control knob .

The radio is switched off when the ignition key is turned to position 0 or removed from the ignition. The radio is switched on again when the ignition key is turned to position 1 or 2.

Note:

The radio can also be switched on even if the ignition key is not inserted, but will switch itself off automatically after one hour to conserve vehicle battery power.

Adjusting the volume

Turn the control knob - Turning the knob clockwise will increase the volume, counterclockwise will decrease the volume.

Audio functions

The AUD key is used to select the BASS, TREBLE and BALANCE functions. Settings for bass and treble are stored separately for the radio, cassette and CD modes. Tone level settings are identified by the vertical bars. The center (flat) setting is shown by one longer bar in the center of the display.

Bass

Press the AUD key repeatedly until “BASS” appears in the display.

Treble

Press the AUD key repeatedly until “TREBLE” appears in the display.

Press the “+” key to increase or the “-” key to decrease the level.

Balance



Press the AUD key repeatedly until “BALANCE” appears in the display.

Press the “L” key to move the sound to the left speaker or the “R” key to move the sound to the right speaker.

1 not available on all models

Centering all audio functions



Push and hold down the “AUD” key. All audio functions (bass, treble, balance and fader) are set to center or flat positions, and

the volume is adjusted to a pre-set level.

Audio system

104

Radio mode**Selecting radio mode**

Press  button.

Selecting the band

```

FM5 ST
 95.5 MHz
AM WB AUD SC

```

Press the key located below the desired band. The band selected is shown in the top line of the display.

```

AM4
 880 kHz
FM WB AUD SC

```



Frequency ranges:	FM	87.9 - 107.9 MHz
	AM	530 - 1710 kHz
	WB	approx. 162 MHz

Manual tuning

```

WB1
CH 1
FM AM AUD SC

```

Press either the  or  button. Step-by-step tuning in ascending or descending order of frequency will take place.

The first three tuning steps will take place without muting. The radio will then be muted and high-speed tuning will take place until the button is released. The following tuning intervals will be shown on the display:

FM	200 kHz
AM	10 kHz
WB	Channels 1-7





Seek tuning

Press either the  or  button. The radio will tune to the next receivable station.

Scan tuning

FM
95.5 MHz
AM WB AUD SC

Press the SC key. Each strong receivable station on the band selected will be tuned in for 8 seconds. The first scan will tune only the stations with a

high signal strength. The second scan will tune every receivable station. By pressing either the , ,  or  buttons, or the “SC” key the scan mode can be cancelled.

Station memory

FM ST
95.5 MHz
AM WB AUD

Ten stations can be stored in the AM and FM bands via the alpha-numeric keypad. The “0” button corresponds to location 10. Weatherband

(WB) channels 1 to 7 can be retrieved via the alpha-numeric keypad and are preset at the factory.

Storing stations

Hold the number button down for approximately 2 seconds. The currently displayed frequency is stored on the selected station button. The storage procedure is confirmed by a short signal tone.

Retrieving a station from memory

Press the desired station button.

Direct frequency input (AM and FM only)

FM ST
--'-- MHz
AM WB AUD SC

Select the band. Press the  button and enter the desired frequency using the alpha-numeric keypad.

Frequencies outside of the frequency ranges (frequencies specified on page 104) will not be accepted. The frequency input mode is cancelled if no button is pressed within 4 seconds.

Audio system

106

Cassette mode**Playing cassettes**

Press the “TAPE” button. When the eject (EJ) key is pressed, the display folds down and the cassette slot becomes visible. Push the cassette into the slot until it engages. The cassette will be pulled in automatically.

Note:

Do not press directly on the radio display face.

Return the display panel to its normal position by folding it back up and pressing gently on the display frame to lock in place.

Important:

If the display is in the down position for more than 20 seconds, 2 successive beeps will be heard. This will continue at 5 second intervals until the display is returned to its normal position.



TAPE NR
SIDE 1
TRK EJ AUD SC

The radio will switch to cassette mode. Track 1 will be played and “SIDE 1” displayed. Track 1 is the side of the cassette which is facing upwards. The cassette deck will automatically detect the type of tape and switch the equalization automatically. A cassette symbol in the display indicates that a tape is in the mechanism. This symbol appears in all modes but not in cassette mode.

The cassette will not be ejected when the radio is switched off or another mode is selected.



NR
NO TAPE
EJ

If a cassette is in the mechanism, cassette mode can be selected by using the “TAPE” button. If no cassette has been inserted, the display will show “NO TAPE”.

Cassette eject

Press the eject (EJ) key. The display will fold down and the cassette will be ejected. Remove the cassette, then fold the display back up manually. The radio will switch back to radio mode automatically.

Note:

The cassette will not be ejected when the radio is switched off.

Important:

If the display is in the down position for more than 20 seconds, 2 successive beeps will be heard. This will continue at 5 second intervals until the display is returned to its normal position.

Track selection

```
TAPE NR  
SIDE 1  
TRK EJ AUD SC
```

Press the track selection (TRK) key. The current track will be displayed as “SIDE 1” or “SIDE 2”. The track will be changed automatically at the end of the tape.

Track search forwards/backwards

```
TAPE NR  
SEEK FWD  
TRK EJ AUD SC
```

Press the  button. “SEEK FWD” will be shown on the display and the track search will run the tape forwards to the start of the next track.

```
TAPE NR  
SEEK RWD  
TRK EJ AUD SC
```

Press the  button. “SEEK RWD” will be shown on the display and the track search will run the tape backwards to the start of the track currently playing. Track search can be interrupted by pressing the same button again.

Note:

The beginning of a track can only be located if there is a break of at least 4 seconds between tracks.

Audio system

108

Fast forward/reverse

TAPE NR
FORWARD
TRK EJ AUD SC

Press the  button. "FORWARD" will appear on the display and fast forward will start.

TAPE NR
REWIND
TRK EJ AUD SC

Press the  button. "REWIND" will appear on the display and fast reverse will start.

Fast forward/reverse is stopped by pressing the same button again, or it will stop automatically at the beginning or the end of the tape. The track will automatically change at the end or beginning of the tape and play will begin.





Scanning

TAPE NR
SCAN FWD
TRK EJ AUD SC

Press the "SC" key. Each track on the cassette will be played for 8 seconds in ascending order.

Note:

The beginning of a track can only be located if there is a break of at least 4 seconds between tracks.

Scan will be interrupted if the , , ,  buttons or the "SC" key is pressed.

Dolby NR¹ (noise reduction system)TAPE BASS
.....|.....
<- NR AUD +>

To enable optimum reproduction of cassettes recorded using the Dolby B system, press the "AUD" key followed by the NR key so the

"NR" in the display is not highlighted. To turn off Dolby B noise reduction, press the "NR" key so the "NR" in the display is highlighted.

¹ Dolby and the double-D symbol  are trademarks of Dolby Laboratories Licensing Corporation. The Dolby noise reduction system is manufactured under licence from Dolby Laboratories Licensing Corporation.

CD mode

General notes on CD mode

Should excessive temperatures occur while in CD mode, “TEMP HIGH” will appear in the display and muting will take place. The unit will then switch back to radio mode until the temperature has decreased to a safe operating level.

Should temperatures occur while in CD mode which are too low, “TEMP LOW” will be displayed, but the CD will play. It will be sensitive to skipping if you are driving over rough roads.

Handle CDs carefully to prevent interference during playback.

Avoid fingerprints and dust on CDs. Do not write on the CDs or apply any label to the CDs.

Clean CDs from time to time with a commercially available cleaning cloth. No solvents, anti-static sprays, etc. should be used.

Replace the CD in its container after use. Protect CDs from heat and direct sunlight.

Warning!

The CD changer ¹ is a Class 1 laser product. There is a danger of invisible laser radiation if the cover is opened or damaged.

Do not remove the cover. The CD changer ¹ does not contain any parts which can be serviced by the user. For safety reasons, have any service work which may be necessary performed only by qualified personnel.

1 Optional equipment

Audio system

110

CD changer installed

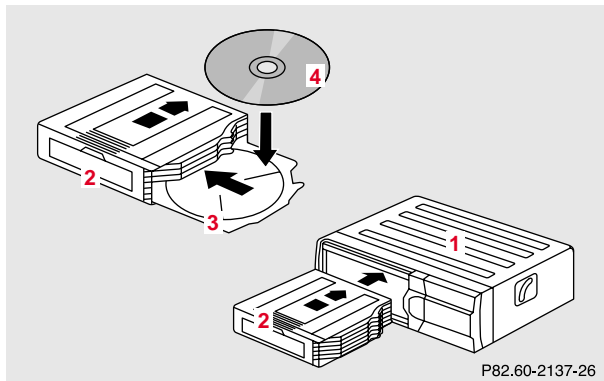

- 1 CD changer ¹
- 2 CD magazine
- 3 CD tray
- 4 CD

If a CD changer ¹ is installed, it can be operated from the front control panel of the radio. A loaded magazine must be installed for CD playing.

1 Optional equipment

Loading/emptying the CD magazine

Slide the changer door to the right and press the eject button . The magazine will be ejected. Remove the magazine. Pull out the CD tray until its stop is reached and place the CDs in the recess of the tray, label side up. Push the tray into the magazine in the direction shown by the arrow. Insert the loaded magazine into the changer.

Important!

Close the door after the magazine has been inserted.

Playing CDs

Press the CD button. The CD most recently played will start at the point where it was last switched off. CDs stored in the magazine can be selected by using the station preset buttons 1-6.

```

CD1
TRACK 1
RDM RPT AUD SC

```

The magazine slot number of the selected CD will then be displayed after “CD”. The number of the track being played will be displayed after “TRACK”.

CD1
NO CD3
RDM RPT AUD SC

If there is no CD in the selected magazine slot, “NO CD” and the corresponding slot number will be displayed

(e.g. “NO CD3”). After the last track on a CD has been played, the next CD will automatically be selected and played.

Skipping tracks forwards/backwards

Press the  button. The next track on the CD will be played.

Press the  button. If the track has been playing for more than 10 seconds, it will revert to the start of that track. If it has been playing for less than ten seconds it will revert to the preceding track. To skip several tracks, the respective button must be pressed until the desired track is reached. If the beginning or end of the CD is reached during the search, the first or last track will be played.

Fast forward/reverse





Press the  button and hold it down for audible fast forward.

Press the  button and hold it down for audible reverse.

CD1
02:46
RDM RPT AUD SC

The search will stop when the button is released. The relative time of the track will be displayed during the search. The search mode will cancel if the beginning or end of the CD is reached.

Scanning

Press the SC key. Each track will be played for 8 seconds in ascending order. The search will stop at the track in question if the , , ,  buttons or the “SC” key is pressed.

Audio system

112

Random play/repeat function

The tracks of the current CD are played in random order when the random feature (RDM) is selected. Press the RDM key to switch on, and press RDM again to switch off.

```
CD1  
TRACK 10  
RDM RPT AUD SC
```

When the repeat function (RPT) has been selected, a particular track can be played for as many times as desired.

Press the RPT key to switch on, and press RPT again to switch off.

Note:

Both functions cannot be used simultaneously.

Direct track selection

Tracks can be selected directly using the buttons on the alpha-numeric keypad. Press the  function button, followed by the track number.

Telephone operation

Various functions of the Mercedes-Benz integrated cellular telephone ¹ can be performed and displayed via the car radio. Further instructions for operating the car telephone can be found in the operation guide for the cellular telephone ¹.

Switching the telephone on and off

```
FM5 ST TEL
 95.5 MHz
FM WB AUD SC
```

Switching on: Press the **TEL** button, “TEL” appears in the corner of the display.

Switching off: Press and hold the **TEL** button until the telephone symbol “TEL” no longer appears in the display, or press the “PWR” button on the phone’s keypad.

¹ Optional equipment

Entering telephone number and starting dialing process

```
S.. ROAM
READY
SND END
```

Enter the desired telephone number using the alphanumeric keypad. The number can have up to 32 digits, but only 13 of these can be

displayed. The dialing process is started by pressing the SND button. The entered number can be corrected using the “CLR” key.

```
S.. ROAM
 5551212
SND CLR END
```

Press the CLR key briefly - and the last digit will be deleted.

Press the CLR key longer - and the complete number will be deleted.

Calling up the phone book

The numbers stored in the telephone memory can be called up via either name or number entries. The memory contents from the portable phone must be downloaded and the telephone menu must be selected in order to call up the phone book. Refer to the “Memory download” section of the cellular telephone operation guide for more information.

Audio system





114

Switching between name search and number search





Press ABC key - Name search

Press NUM key - Number search

Searching and selecting phone book entries by name

Press the ABC key. The current name is shown on the display. The stored entries in alphabetical order can be selected using the  or  button. By pressing the  or  buttons, the stored entries can be selected according to alphabetical initial letters (e.g. A-Adam, B-Brown, M-Miller).

Searching and selecting phone book entries by number



Press the NUM key. The current number is shown on the display. The stored entries can be selected in numerical order using the  or  button. By pressing the  or  buttons, the stored entries can be selected in increments of 5 (e.g. Entry no. 2, Entry no. 7, etc.).

Placing a call

```
S.. ROAM
      5551212
SND CLR END
```

When a number or a name has been selected using the method described above, press the SND key.

Manual repeat dialing (redial)

The last number entered can be re-selected by pressing the SND key once and the call can be placed by pressing the SND key a second time. The last dialed telephone number is shown on the display. Using the  or  button, the numbers stored in the re-dial memory of the telephone can be selected.

```
S.. ROAM L2
      5551212
SND CLR END
```

The abbreviation L and the number in the memory are shown in the top line of the display.

Accepting incoming call in telephone mode

With an incoming call, the ringing tone will be heard and the message “CALL” appears in the display. Press the SND key to answer the call.

Accepting incoming call in tape, CD or radio mode

If the telephone is activated in the background (telephone symbol in the display), then a switch is made automatically to telephone when an incoming call is received. The audio source is muted, the ringing tone is heard and the message “CALL” appears. After the call has been terminated, the previously selected audio source is resumed.

Terminating call

A current call can be terminated by pressing the END button.

Component malfunctions

The radio, CD changer ¹, and Mercedes-Benz integrated cellular telephone ¹ are part of a fiberoptic networked system. Failure of one of the components can lead to malfunctions of the other components. Please contact your authorized Mercedes-Benz Center or call 1-800-FOR-MERCEdes for more information in the event of a malfunction.

1 Optional equipment

Interior equipment

Power windows

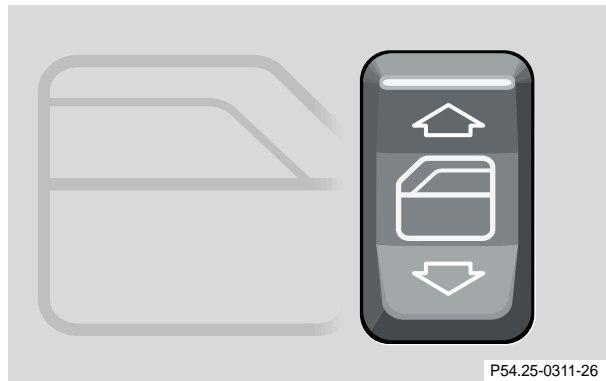



Power window switches located on center console

116

Turn key in steering lock to position 1 or 2.

Press switch in to resistance point:

 to open



 to close

Release switch when window is in desired position.



Warning!

When closing the windows, be sure that there is no danger of anyone being harmed by the closing procedure.

When leaving the vehicle, always remove the key from the steering lock, and lock the vehicle. Do not leave children unattended in the vehicle, or with access to an unlocked vehicle. Unsupervised use of vehicle equipment can cause serious personal injury.

The closing procedures can be immediately reversed by either pressing the switch , turning the key to the unlocking position, or pressing button  on the remote control, and holding it.

Express opening of door windows

Press switch  past resistance point and release – window lowers to fully open position. To interrupt procedure, briefly press  or .

Note:

The power windows can also be closed with the key or infrared remote control while locking the vehicle doors or trunk, see page 41.

Important!

Do not close a door with the windows fully closed while the power supply is interrupted (battery disconnected or empty). Doing so could damage the window frame.

The power windows should first be resynchronized.

After a power interruption, first synchronize the windows to enable activation of the soft top.

Synchronizing power windows

When opening a door after the power supply was interrupted (battery disconnected or low), the window will open slightly, indicating that the Express feature should be resynchronized.

Press  side of power window switch until the window is completely closed and hold for additional 2 seconds. Repeat procedure for each window.

The automatic full opening procedure of the windows should now be restored.

Interior equipment

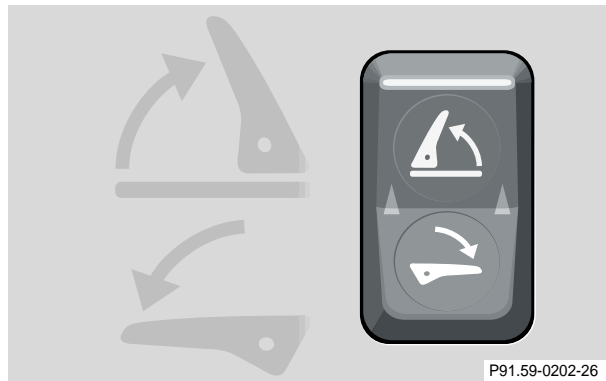
Roll bar

The switch is located in the center console.

Turn key in steering lock to position 2.

Press switch

Upper half = to raise

Lower half = to lower

The lowering or raising procedure is immediately interrupted by releasing the roll bar switch.

118

If the roll bar was raised using the switch, it will be automatically lowered when activating the soft top switch.

The roll bar will be automatically raised in an accident or in a potentially dangerous driving situation. A ratchet noise can be heard when the roll bar is automatically raised.

The roll bar can be lowered again after an automatic deployment by pressing the upper half of the roll bar switch (for at least 5 seconds) until the roll bar drive mechanism audibly engages. Then press the lower half of the switch to lower the roll bar.

Warning

This vehicle is a two occupant vehicle. The rear storage area should never be used by any persons. Raising or lowering of the roll bar could injure rear seated occupants.

Before operating the roll bar switch make sure that the roll bar's path is clear and no persons due to inattention are injured by the moving roll bar.

For your own safety we recommend to drive with the roll bar raised, if

- **the outside temperature is below +5°F (-15°C)**
- **the soft top is closed and pets are placed in the rear storage area.**

Items being transported in the area behind the seats should be placed in such a manner as not to affect the movement of the roll bar when being raised.

Note:

If the indicator lamps in the switch are blinking or if the warning lamp in the instrument cluster comes on, then a malfunction has been detected.

In this case, drive only with the roll bar raised until the problem has been corrected. Raise the roll bar by pressing the upper half of the roll bar switch. The indicator lamps in the switch will go out, however, the warning lamp in the instrument cluster will stay on.

Have the system checked at your authorized Mercedes-Benz Center as soon as possible.

Important!

The roll bar is intended to be a safety enhancement to the other features designed into the vehicle. No system in any vehicle can eliminate the possibility of serious injury or fatality in an accident. Properly fastened seat belts and child restraints must be used!

Interior equipment

120

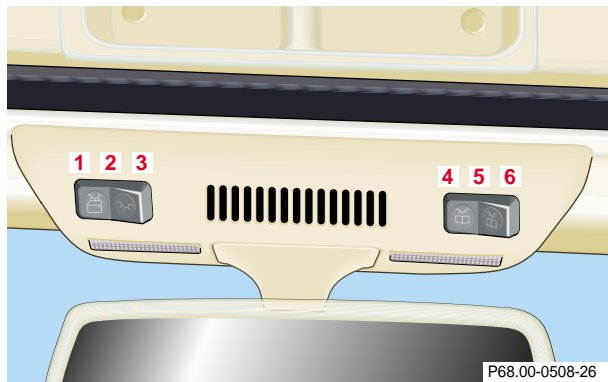
Interior lighting**Interior lamps**

The switches are located above the inside rear view mirror.

- 1 Interior lamps are switched on, and off (soft fade) delayed, when unlocking or locking the vehicle, or when opening or closing either door. However, there will be no (soft fade) delay when the key is in steering lock position 2.

- 2 Interior lamps switched off
- 3 Interior lamps switched on continuously

Reading lamps

- 4 Left reading lamp switched on
- 5 Reading lamps switched off
- 6 Right reading lamp switched on

Entrance lamps in footwells, exit lamps in doors

These lamps are switched on and off by the door contact switches.

Note:

To prevent the vehicle battery from being discharged, do not leave doors open for a long period of time.

Sunshade, manual

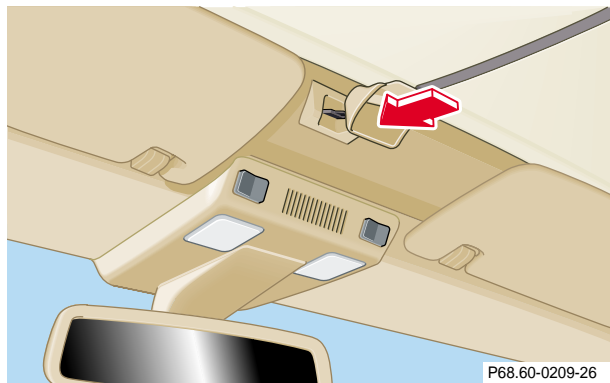

Warning

Do not operate the sunshade while driving. Adjusting the sunshade while driving could cause the driver to lose control of the vehicle.

To close:

Slide handle of sunshade along Panorama roof and engage in lock.

To open:

Disengage handle from lock, and guide sunshade until fully retracted. Do not let the sunshade snap back.

Interior equipment

122

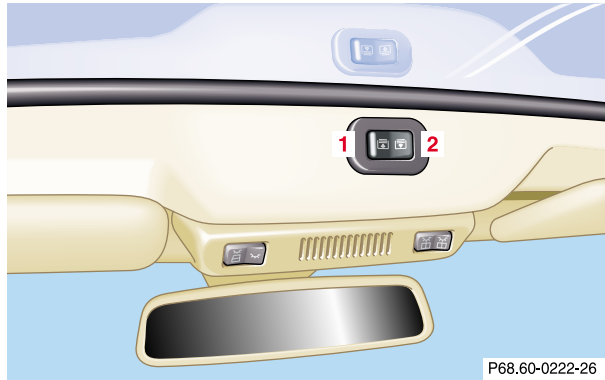
Power sunshade

The switch is located above the inside rear view mirror.

Turn key in steering lock to position 2.

- 1** Press and hold to close.
- 2** Press and hold to open.

Warning

Do not operate the sunshade while driving. Adjusting the sunshade while driving could cause the driver to lose control of the vehicle.

In case the procedure causes potential danger, the procedure can be immediately halted by releasing the sunshade switch.

Sun visors

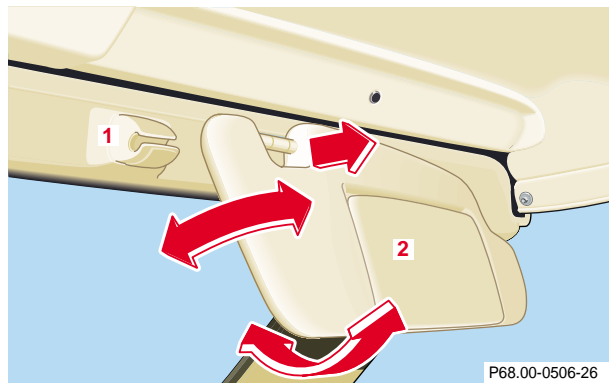

Swing sun visors down to protect against sun glare.

If sunlight enters through a side window, disengage visor from inner mounting (1) and pivot to the side.

Illuminated vanity mirror

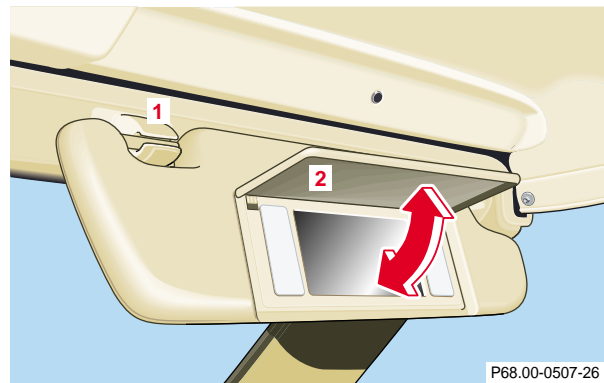

With the visor engaged in its inner mounting (1), the lamp can be switched on by opening the cover (2).

Warning!

Do not use the driver's vanity mirror while driving.

Interior equipment

124

Interior

Warning!

To help avoid personal injury during a collision or sudden maneuver, exercise care when stowing things. Put luggage or cargo in the trunk if possible.

Luggage nets cannot secure hard or heavy objects.

Storage compartment (eyeglasses compartment) in the dashboard

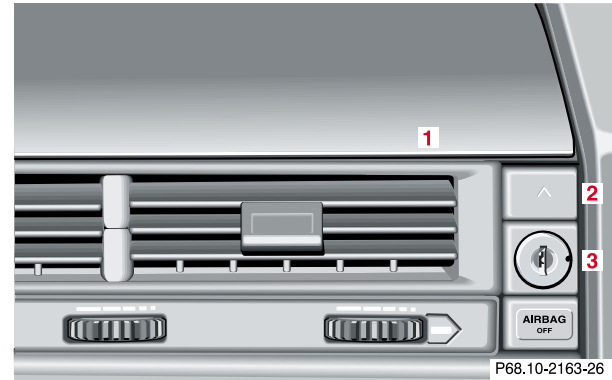

- 1 Storage compartment (eyeglasses compartment)
- 2 Button for storage compartment
- 3 Lock

Opening compartment (1):

Press button (2).

Locking:

Turn master key in lock (3) to the right and remove.

Unlocking:

Turn master key back to vertical position.

Caution!

Keep compartment lids closed. This will prevent stored objects from being thrown about and injuring vehicle occupants during an accident or sudden maneuver.

Note:

The storage compartments may be locked and unlocked by using the master key in lock (3).

Interior central locking system

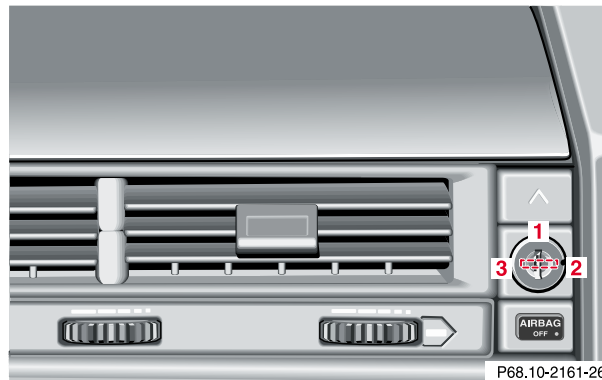

- 1 Initial position (integrated with vehicle central locking system)
- 2 Separate locking of storage compartments
- 3 Emergency operation

Interior equipment

126

The following storage compartments are part of the interior central locking system:

- eyeglasses compartment in the dashboard
- console storage compartments,
- rear storage compartments.

Integration with vehicle central locking system

When locking or unlocking the vehicle from the outside by using the master key, the interior storage compartments are also locked or unlocked (with lock in position 1).

Separate locking of storage compartments

Locking:

Turn master key to position 2 and remove from lock. The storage compartments remain locked- even if the vehicle is unlocked from the outside.

Unlocking:

Turn master key to position 1 and remove from lock.

If the vehicle was locked from the outside, the storage compartments remain in the locked mode until the vehicle is unlocked again from the outside.

Note:

If the interior storage compartments are to remain locked (for example while in a repair shop), leave only the valet key with the vehicle.

When unlocking a door from the inside, on a vehicle previously locked from the outside, the storage compartments still remain locked.

In case of a malfunction the eyeglasses compartment can still be opened. To do so, turn the master key to position 3, return it to position 1, remove it from the lock and press button .

Armrest

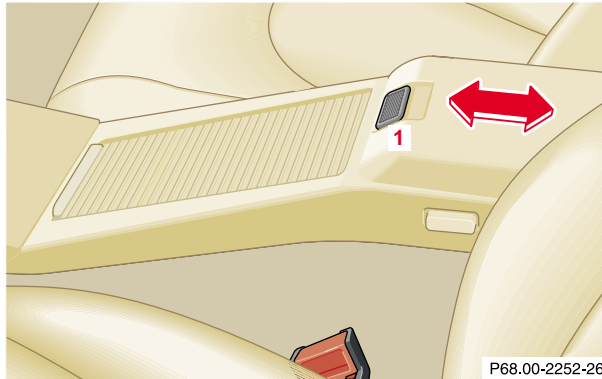

To adjust:
Press button (1) and slide armrest forward or backward.

Console storage compartments

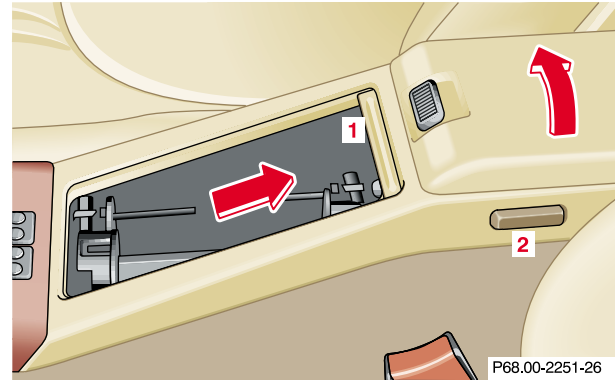

To open front compartment:

Slide cover (1) back.

Opening rear compartment:

Press button (2).

The compartments can be locked and unlocked with the central locking system.

Interior equipment

128

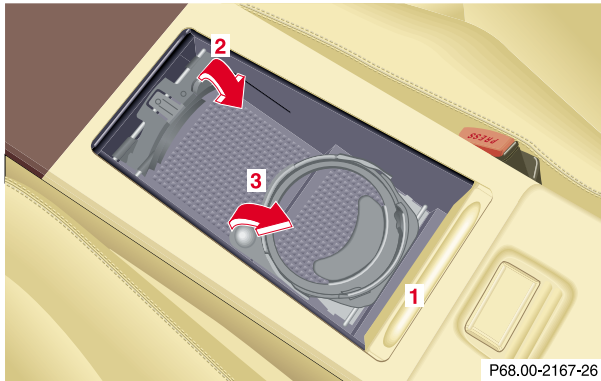
Cup holder**To open compartment:**

Slide cover (1) back.

To open cup holder (2):

Lift handle in direction of arrow.

To close cup holder (3):

Lift handle in direction of arrow.

Warning!

Keep cup holder closed while traveling. Place only containers that fit into the cup holder to prevent spills.

Do not fill containers to a height where the contents could spill during vehicle maneuvers, especially hot liquids.

Parcel net in passenger footwell

A small convenience parcel net is located in the passenger footwell. It is for small and light items, such as road maps, mail, etc.

Warning!

Do not place heavy or fragile objects, or objects having sharp edges, in the parcel net.

In an accident, during hard braking or sudden maneuvers, they could be thrown around inside the vehicle, and cause injury to vehicle occupants.

Door pockets

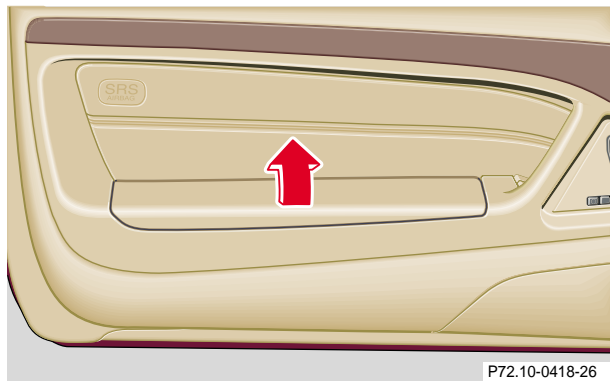

To open:

Lift cover.

Warning!

For unobstructive inflation of side impact airbags, keep door pocket lids closed.

Rear storage compartment

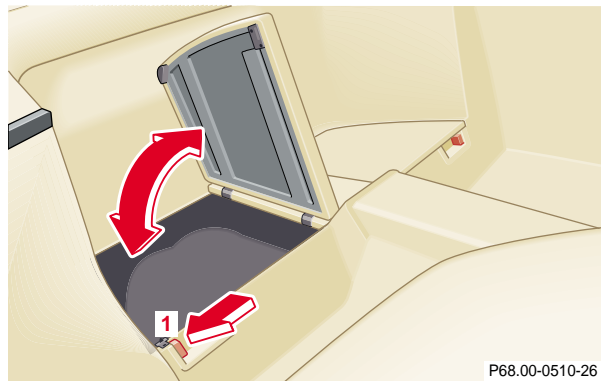

To open compartment:

Press button (1) and lift cover.

Caution!

Keep compartment lids closed. This will prevent stored objects from being thrown about and injuring vehicle occupants during an accident or sudden maneuver.

Interior equipment

130

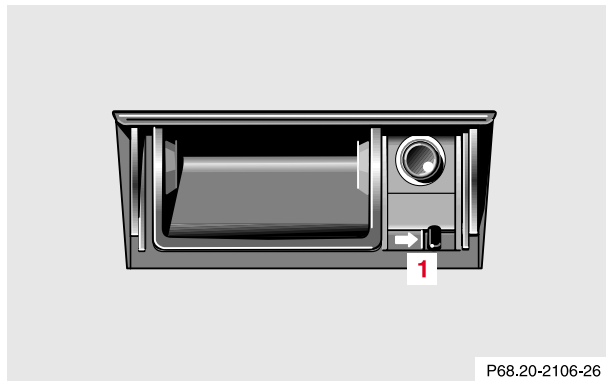
Ashtray with lighter

Ashtray in center console

By touching the bottom of the cover lightly, the ashtray opens automatically.

Prior to removing the ashtray insert, move the gear selector lever to position “N”.

Warning!

Remove front ashtray only with vehicle standing still. With the gear selector lever in position “N”, turn off the engine and set the parking brake. Otherwise the vehicle might move as a result of unintended contact with the gear selector lever.

To remove ashtray:

Push sliding knob (1) toward the right to eject the insert.

To install ashtray:

Install insert into ashtray frame and push down to engage.

Lighter

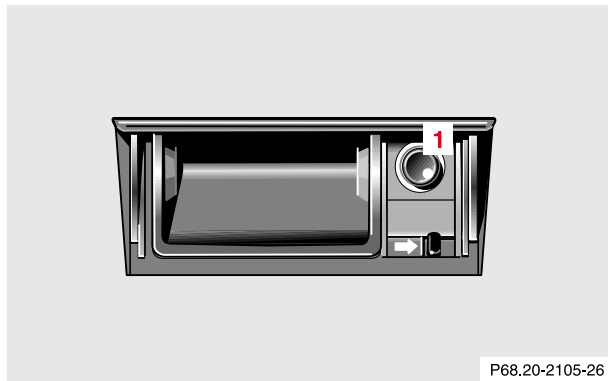

1 Lighter

Turn key in steering lock to position 1 or 2.

Push in lighter (1); it will pop out automatically when hot.

Warning!

Never touch the heating element or sides of the lighter, they are extremely hot, hold at knob only.

When leaving the vehicle always remove the key from the steering lock. Do not leave children unattended in the vehicle, or with access to an unlocked vehicle. Unsupervised use of vehicle equipment may cause serious personal injury.

Note:

The lighter socket can be used to accommodate electrical accessories up to a maximum 85 W.

Telephone, general**Warning!**

Your concentration on the road and traffic conditions must take priority. Only use the telephone¹ when road and traffic conditions permit.

Park if you wish to use the handset rather than the hands-free device to make a call.

Bear in mind that at a speed of just 30 mph (approximately 50 km/h), your vehicle is covering a distance of approximately 50 feet (approximately 14 m) every second.

Never operate radio transmitters equipped with a built-in or attached antenna (i.e. without being connected to an external antenna) from inside the vehicle while the engine is running. Doing so could lead to a malfunction of the vehicle's electronic system, possibly resulting in an accident and personal injury.

See separate instruction manual for instructions on how to operate the telephone.

- 1 Observe the legal requirements in all countries concerned.

Garage door opener

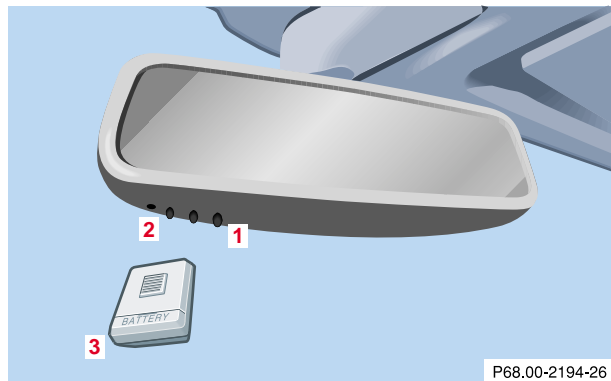

- 1 Signal transmitter keys
- 2 Indicator lamp
- 3 Portable remote control transmitter

The built-in remote control is capable of operating up to three separately controlled objects.

Warning!

When programming a garage door opener, the door moves up or down.

When programming or operating the remote control make sure there is no possibility of anyone being harmed by the moving door.

Notes:

Certain types of garage door openers are incompatible with the integrated opener. If you should experience difficulties with programming the transmitter, contact your authorized Mercedes-Benz Center, or call Mercedes-Benz Client Assistance Center (in the USA only) at 1-800-FOR-MERCEDES, or Customer Service (in Canada) at 1-800-387-0100.

Garage door opener

134

For operation in the USA only: This device complies with Part 15 of the FCC Rules. Operation is subject to the following two conditions:

- (1) This device may not cause harmful interference, and
- (2) this device must accept any interference received, including interference that may cause undesired operation.

Any unauthorized modification to this device could void the user's authority to operate the equipment.

Programming or reprogramming the integrated remote control:

1. Turn electronic key in steering lock to position 1 or 2.
2. Hold the end of the hand-held transmitter of the device you wish to train approximately 2 to 5 inches (5 cm to 12 cm) away from the surface of the integrated remote control located on the inside rear view mirror, keeping the indicator lamp in view.

3. Using both hands, simultaneously push the hand-held transmitter button and the desired integrated remote control button. Do not release the buttons until completing step 4.
4. The indicator lamp on the integrated remote control will flash, first slowly and then rapidly. When the indicator lamp flashes rapidly, both buttons may be released (the rapid flashing lamp indicates successful programming of the new frequency signal). To program the remaining two buttons, follow steps 1 through 4.

Note:

If, after repeated attempts, you do not successfully program the integrated remote control device to learn the signal of the hand-held transmitter, the garage door opener could be equipped with the "rolling code feature".

Rolling code programming:

To train a garage door opener (or other rolling code devices) with the rolling code feature, follow these instructions after completing the “Programming” portion of this text. (A second person may make the following training procedures quicker and easier.)

1. Locate training button on the garage door opener motor head unit. Exact location and color of the button may vary by garage door opener brand. If there is difficulty locating the transmitting button, reference to garage door opener operator’s manual.
2. Press “training” button on the garage door opener motor head unit (which activated the “training light”).

Note:

Following step 2, there are 30 seconds to initiate step 3.

3. Firmly press and release the programmed integrated remote control transmit button. Press and release same button a second time to complete the training process. (Some garage door openers may require you to do this procedure a third time to complete the training.)
4. Confirm the garage door operation by pressing the programmed button on the integrated remote control transmitter.

Canadian programming:

During programming, your hand-held transmitter may automatically stop transmitting. Continue to press and hold the integrated remote control transmitter button (note steps 2 through 4 in the “Programming” portion) while you press and re-press (“cycle”) your hand-held transmitter every two seconds until the frequency signal has been learned. The indicator lamp will flash slowly and then rapidly after several seconds upon successful training.

Garage door opener

136

Operation of remote control:

1. Turn electronic key in steering lock to position 1 or 2.
2. Select and press the appropriate button to activate the remote controlled device. The integrated remote control transmitter continues to send the signal as long as the button is pressed – up to 20 seconds.

Erasing the remote control memory:

1. Turn electronic key in steering lock to position 1 or 2.
2. Simultaneously holding down the left and right side buttons for approximately 20 seconds, or until the control lamp blink rapidly, will erase the codes of all three channels.

Hardtop or panorama roof (optional)

The removal or attachment of the hardtop can be carried out by 2 persons.

Warning!

Do not place your hands between the hardtop and the car body while the hardtop is being locked or unlocked. Serious personal injury may occur.

Removing hardtop

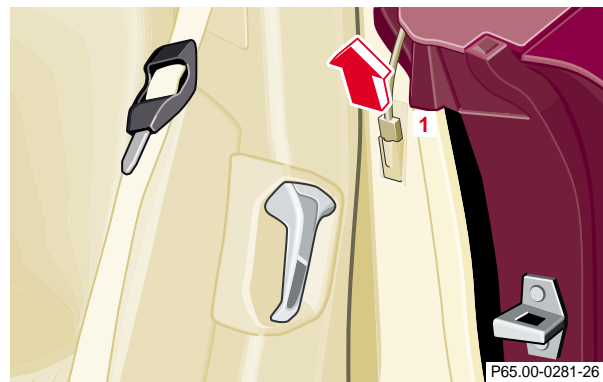

1. Engage parking brake.
2. Open doors.
3. Disconnect plug (1) for rear window defroster.

Hardtop

138

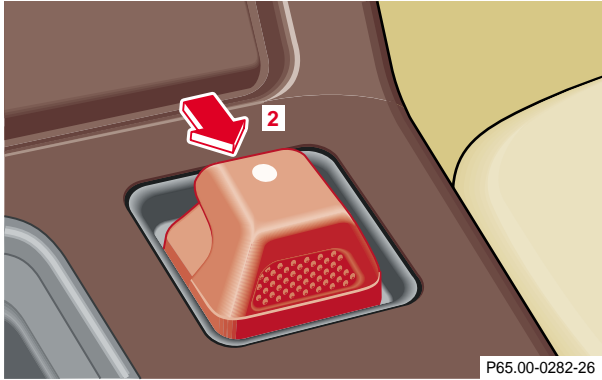

The unlocking procedure begins after approx. 2 seconds:

- The roll bar lowers.
- The indicator lamp in the soft top switch lights up.
- The hardtop unlocks.

4. Within 10 seconds of turning key in steering lock to position 2 (engine not running), slide soft top switch (2) back and hold.

Please note, if soft top switch is activated after 10 seconds have expired, turn the key back to position 0 first before the hardtop removing procedure can be started again at step 4.

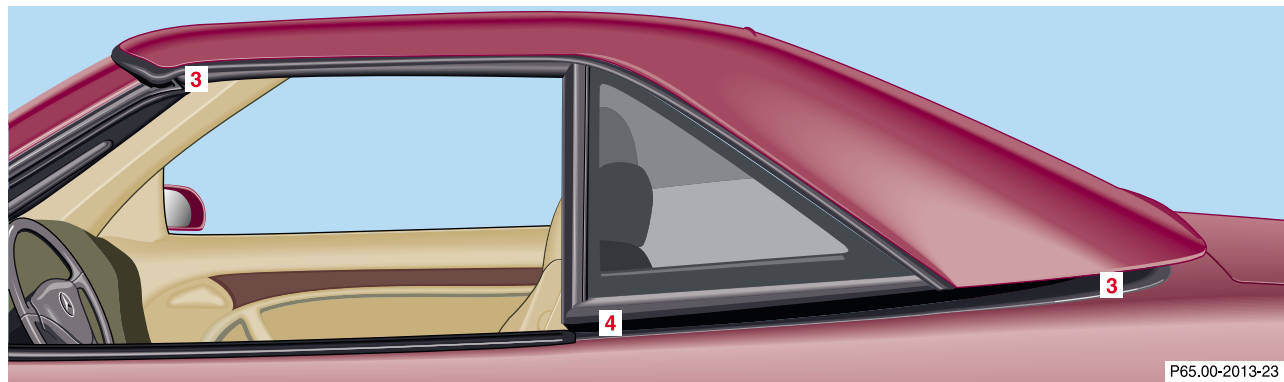

5. After the hardtop has unlocked, remove the key from the steering lock and turn radio and telephone off to lower antenna. The indicator lamp in the soft top switch should go out.

Important!

Removal of the key from the steering lock is a safety measure ensuring that the key cannot be turned to position 2 and the soft top switch is without function should anybody push the switch forward causing the roof locking mechanism to work. If hands are at that moment between roof and car body they can be badly injured.

6. Lift the hardtop vertically from its attachment points (3) and locating points (4) and carefully remove to the rear. Exercise caution when maneuvering the top. To avoid paint damage, the top's mounting pins must not be allowed to contact the body.

Warning!

To prevent possible accidents, drive the vehicle only with the hardtop either completely closed and locked, or fully lowered into its storage compartment.

Hardtop

140

Attaching hardtop

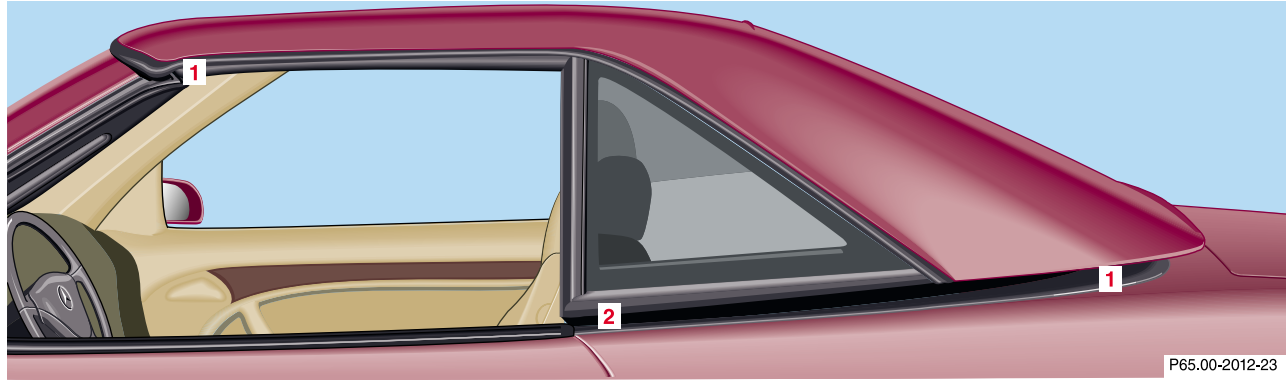

P65.00-2012-23

1. Engage parking brake and turn key in steering lock to position 2.
2. Lower roll bar, see page 118.
3. Open doors.
4. Turn radio and telephone off to lower power antenna, turn key in steering lock to position 0 and remove.
5. From the rear of the vehicle, lift the hardtop carefully over the attachment points (1) and locating points (2). First guide the rear pins of the top vertically into the rear attachment points, then lower the roof onto the vehicle and locate the front locking pins. Exercise caution when maneuvering the top. To avoid paint damage, the top's mounting pins must not be allowed to contact the body.

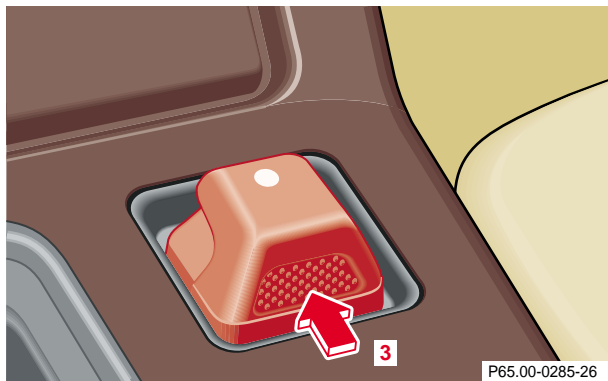

6. Turn key in steering lock to position 2. The indicator lamp in the soft top switch lights up.
7. Slide soft top switch (3) forward - the hardtop should lock and the indicator lamp in the switch should go out.

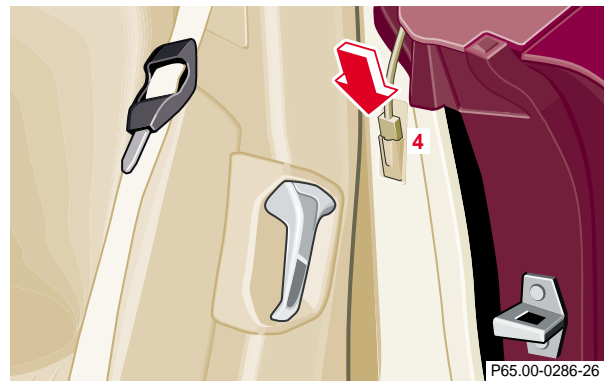

8. Connect plug (4) for rear window defroster.

Hardtop

142

Warning!

The raising or lowering procedure of the soft top is not completed if the indicator lamp in the soft top switch:

- **does not go out (with key in steering lock position 2),**
- **blinks when starting to drive and an alarm sounds.**

When safe to do so, immediately stop the vehicle and lock the soft top:

- **Turn key in steering lock to position 2,**
- **Slide soft/hardtop switch forward.**

Do not drive the car with the hardtop not locked, as that could cause personal injury to you or your passenger, or personal injury or property damage to others.

Notes:

For safety reasons, the hardtop can only be unlocked while the vehicle is standing still, and within 10 seconds after turning the key to steering lock position 2 or beyond.

If the indicator lamp in the soft top switch blinks while activating the switch, the battery voltage may be insufficient - start engine to charge battery before shutting engine off and attempting to unlock the roof again.

If the indicator lamp continues to blink, remove the hardtop (see page 137), and have the system checked at your authorized Mercedes-Benz Center as soon as possible.

Soft top

A minimum height clearance of 6.5 ft (2 m) is required to lower or raise the soft top.

Do not lower a frozen soft top until thawed and dry. Doing so may result in damage not covered by the Mercedes-Benz Limited Warranty.

To prevent mildew, the soft top must be dry before lowering it into the storage compartment.

The soft top should not be lowered or raised at outside temperatures below +5°F (-15°C), since the material becomes less pliable with lower temperatures.

The lowering or raising procedure is immediately interrupted by releasing the soft top switch.

Warning!

Before operating the soft top switch make sure that no persons due to inattention are injured by the moving parts (roll bar, soft top frame and soft top lid).

Hands must never be placed near the roll bar, soft top frame, upper windshield area or soft top storage compartment while the soft top is being locked or unlocked. Serious personal injury may occur.

Soft top

144

Lowering soft top

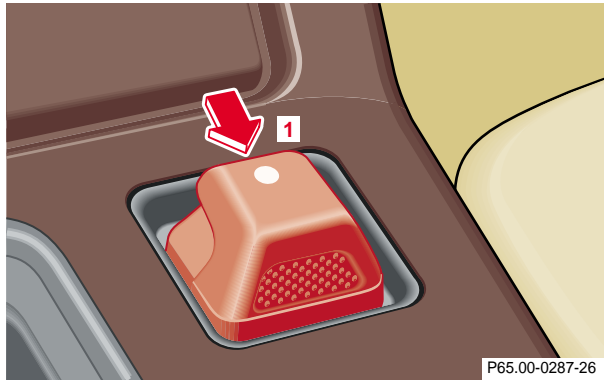

1. Engage parking brake.
2. Turn key in steering lock to position 2.
3. Slide soft top switch (1) back and hold:
 - The side windows lower
 - The roll bar lowers.
 - The indicator lamp in the soft top switch lights up.

- The soft top is lowered into the soft top storage compartment.
- The storage compartment cover closes and locks.
- The indicator lamp in the switch goes out - the lowering procedure is completed.

If the soft top switch is held or is released and slid back again within approx. 2 seconds, the side windows will close. If the roll bar was previously in the upright position, it will return to that position.

However, the side windows and the roll bar can also be activated using their respective switches.

Note:

A wet or frozen soft top must not be folded until thawed and dry.

Raising soft top

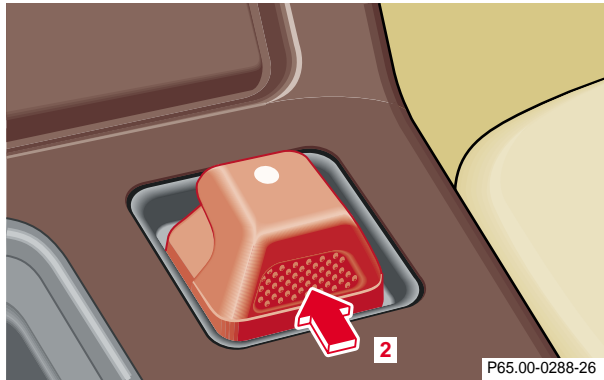

1. Engage parking brake
2. Turn key in steering lock to position 2.
3. Fold down sun visors.
4. Slide soft top switch (2) forward and hold:
 - The side windows lower.
 - The roll bar lowers.
 - The indicator lamp in the soft top switch lights up.
 - The soft top closes and locks.

Note:

If the soft top does not engage in the windshield header attachment points, then release the soft top switch. Reach into the grip (3) and guide the pins into their respective locks while pulling down, slide soft top switch (2) forward again.

- The indicator lamp in the soft top switch goes out - the closing procedure is completed.

Soft top

146

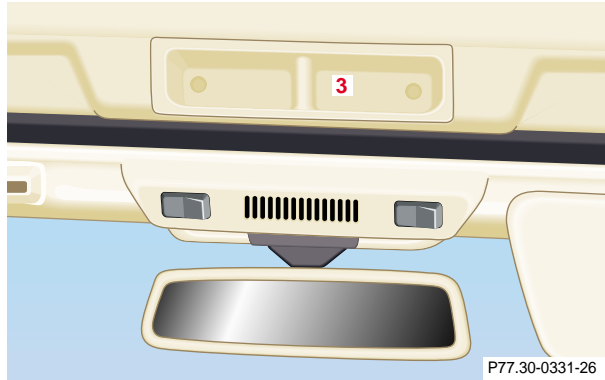

If the soft top switch is held or is released and slid forward again within approx. 2 seconds, the side windows will close. If the roll bar was previously in the upright position, it will return to that position.

However, the side windows and the roll bar can also be activated using their respective switches.

Warning!

The soft top is not locked:

- if the indicator lamp in the soft top switch does not go out (key in steering lock position 2),
- if the indicator lamp blinks, and a warning sounds for 10 seconds when starting to drive.

Stop the vehicle and before continuing to drive, lock the soft top:

The key should be in steering lock position 2.

Slide soft top switch forward.

If the soft top is not locked, it may fold back or forward when driving.

During soft top operation, do not place your hands near the roll bar, soft top frame, upper windshield area or soft top storage compartment. Serious personal injury may occur.

For safety reasons, the soft top cannot be unlocked while driving.

However, if the soft top is not completely locked, it can be locked while driving by pushing the soft/hardtop switch forward.

If the indicator lamp in the soft top switch blinks while activating the switch,

- the battery voltage may be insufficient - start engine and let run while activating switch,
- the system may be overloaded (for example after lowering or raising the soft top approx. 5 consecutive times) - after approx. 2 minutes the soft top switch may be activated again,
- and the power supply was interrupted (battery disconnected or empty), the soft top cannot be fully raised or lowered.

To raise the soft top, for safety reasons, first remove key from steering lock. Lower soft top by hand into compartment, and resynchronize the power windows. See page 116.

To lower the soft top, first resynchronize the power windows. See page 116.

If the indicator lamp continues to blink, lock the soft top manually. See page 253.

Have the system checked at your authorized Mercedes-Benz Center as soon as possible.

Note:

If the roll bar was raised automatically, the process of raising or lowering the soft top will take somewhat longer, as the roll bar must first be lowered.

Whenever possible, park vehicle in the shade as continuous exposure to sun rays can prematurely deteriorate the soft top material.

Permanent creases in the plastic window, caused by storage of the soft top in the storage compartment, cannot be avoided.

The soft top may become moldy if it is kept in the storage compartment for an extended period.

Therefore, we recommend raising and airing it thoroughly with the side windows open (do not expose it to the sun) at regular intervals during the wet and cold seasons.

Wind screen

148

Wind screen

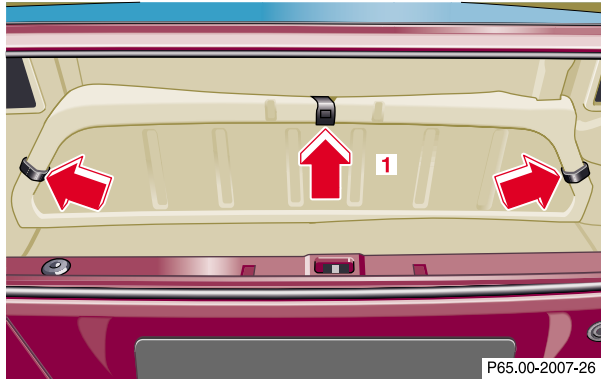

The wind screen is stored in a trunk mounted container (1) which is fastened by clamps (arrows).

Installation

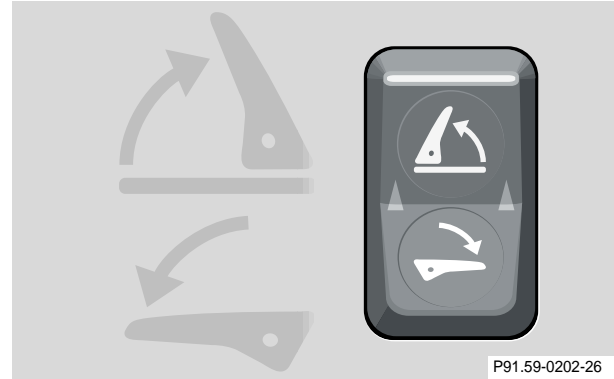

1. Raise roll bar partially using switch on center console, see page 118.

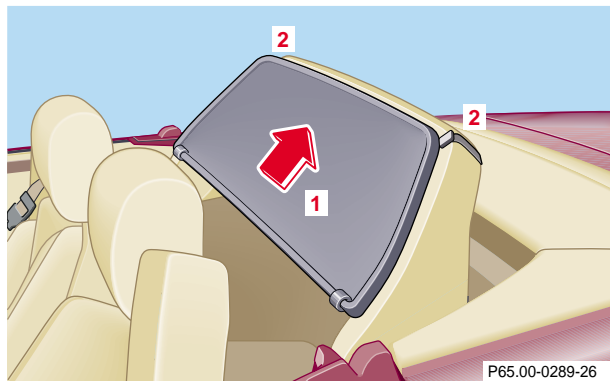

2. Position top end of wind screen at bottom of roll bar. The hooks at bottom of wind screen must point rearward.
3. Slide wind screen up into roll bar (1), using care not to get the attachment straps (2) caught.
4. Raise roll bar completely.

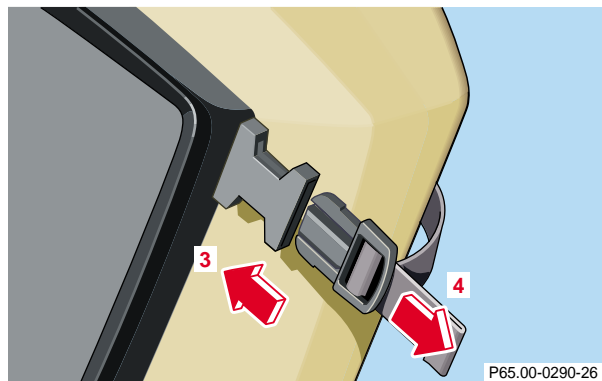

5. Wrap attachment straps around roll bar and insert tabs into latches (3).
6. Tighten straps (4).
7. Lower roll bar.

Wind screen

150

Setting up

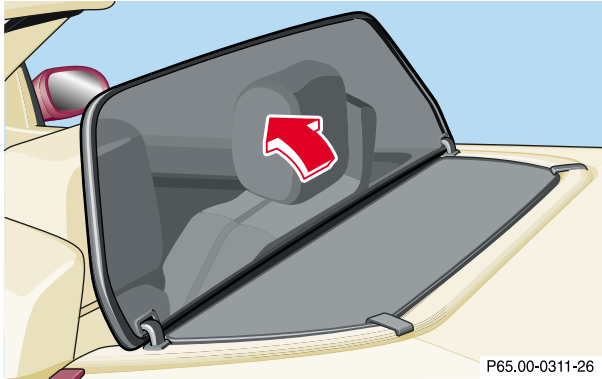

Push top of wind screen fully forward against internal stop.

Warning!

The rear storage area should never be occupied by passengers since the vehicle is a 2 seater. Furthermore, with the wind screen in place there is a risk of injury, should the roll bar be deployed.

Removal

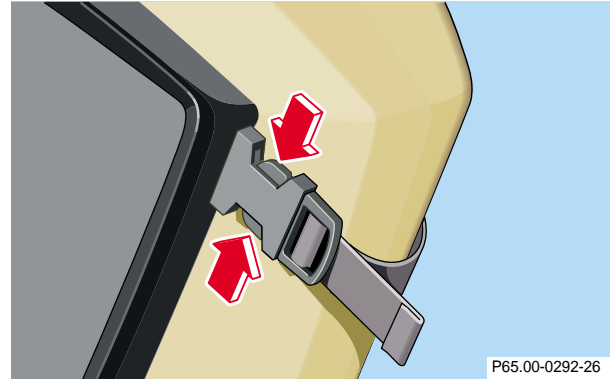

1. Fold down top of wind screen.
2. Raise roll bar using switch on center console.
3. Disconnect attachment strap latches by squeezing latch.
4. Lower roll bar partially.

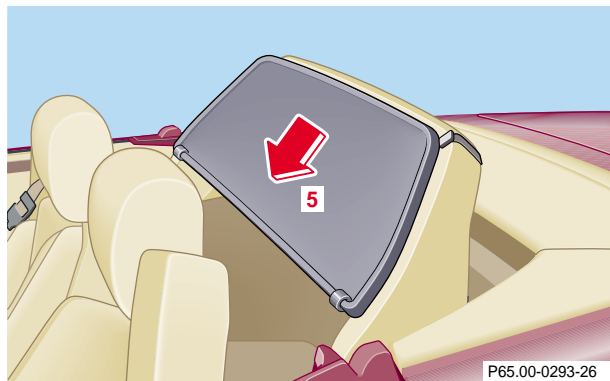

5. Pull wind screen down (5) and remove from roll bar.

The wind screen can be stored in a trunk mounted container.

Antenna

The antenna extends when switching on the radio and/or telephone.

Note:

To retract the antenna (e.g. when entering a car wash) both radio and telephone must be switched off.

Contents – Driving

152

Driving

Control and operation of radio

transmitters 153

Radio, telephone and

two-way radio 153

The first 1 000 miles

(1 500 km) 154

Maintenance 154

Tele Aid 155

Catalytic converter 163

Emission control 164

Steering lock 165

Starting and turning off

the engine 167

Before starting 167

Starting 167

Turning off 167

Automatic transmission 168

Driving 168

Accelerator Position 169

Selector lever positions 169

Maneuvering 172

Stopping 172

Program mode

selector switch 173

Emergency Operation 174

Parking brake 175

Driving instructions 176

Drive sensibly - Save fuel 176

Drinking and driving 176

Pedals 176

Power assistance 177

Brakes 177

Driving off 178

Parking 178

Tires 179

Aquaplaning 180

Tire traction 180

Tire speed rating 181

Snow chains 181

Vehicles with sport

package 181

Winter driving

instructions 182

Winter driving 183

Block heater 183

Deep water 184

Traveling abroad 184

Cruise control 185

Brake assist system (BAS) 188

Antilock brake system (ABS) 190

ABS control 191

Electronic Stability Program

(ESP) 192

Synchronizing ESP 193

ESP Control Switch 194

Level control system 196

Level control switch

positions 196

Normal Level 197

Wheel Change Switch 198

Adaptive Damping System

(ADS) 199

Adaptive damping system

adjustment 199

What you should know at the gas

station 200

Fuel supply 200

Fuel 200

Check regularly and before

a long trip 202

Control and operation of radio transmitters

Radio, telephone and two-way radio

Warning!

Please do not forget that your primary responsibility is to drive the vehicle. Only operate the radio, telephone¹ or two-way radio¹ if road and traffic conditions permit.

Bear in mind that at a speed of just 30 mph (approximately 50 km/h), your vehicle is covering a distance of approximately 50 feet (approximately 14 m) every second.

- 1 Observe all legal requirements.

Telephones and two-way radio

Warning!

Never operate radio transmitters equipped with a built-in or attached antenna (i.e. without being connected to an external antenna) from inside the vehicle while the engine is running. Doing so could lead to a malfunction of the vehicle's electronic system, possibly resulting in an accident and personal injury.

Radio transmitters, such as a portable telephone or a citizens band unit should only be used inside the vehicle if they are connected to an antenna that is installed on the outside of the vehicle.

Refer to the radio transmitter operation instructions regarding use of an external antenna.

The first 1 000 miles

154

The first 1 000 miles (1 500 km)

The more cautiously you treat your vehicle during the break-in period, the more satisfied you will be with its performance later on. Therefore, drive your vehicle during the first 1 000 miles (1 500 km) at moderate vehicle and engine speeds.

During this period, avoid heavy loads (full throttle driving) and excessive engine speeds.

Avoid accelerating by kickdown. It is not recommended to brake the vehicle by manually shifting to a lower gear. We recommend that you select positions “3”, “2” or “1” only at moderate speeds (for hill driving).

After 1 000 miles (1 500 km) speeds may be gradually increased to the permissible maximum.

Maintenance

Approximately 30 days or 2000 miles (2000 km) prior to the next recommended service, the remaining distance or days are displayed in the main odometer field. See Flexible service system on page 80.

We strongly recommend that you have your vehicle serviced by your authorized Mercedes-Benz Center, in accordance with the Service Booklet at the times called for by the FSS.

Failure to have the vehicle maintained in accordance with the Service Booklet at the designated times/mileage may result in vehicle damage not covered by the Mercedes-Benz Limited Warranty.

Tele Aid



Important!

The initial activation of the Tele Aid system may only be performed by completing the subscriber agreement and placing an acquaintance call using the “SOS” button. Failure to complete either of these steps will result in a system that is not activated.



If you have any questions regarding activation, please call the Response Center at 1-800-756-9018 (in the USA) or 1-888-923-8367 (in Canada).

(Telematic Alarm Identification on Demand)

The Tele Aid system consists of three types of response; automatic and manual emergency, roadside assistance and information.

The Tele Aid system is always operational, providing that the vehicle’s battery is charged and properly connected. To activate, press the “SOS” button, the Roadside Assistance button  or the Information button , depending on the type of response required.

System self-check

Initially, after turning the key in steering lock to position 2, malfunctions are detected and indicated (the indicator lamps in the “SOS” button, the Roadside Assistance button  and the Information button  stay on longer than 5 seconds or do not come on).

If a malfunction is indicated as outlined above, have the system checked at the nearest Mercedes-Benz Center as soon as possible.

Important!

Always make sure that the indicator lamp in the “SOS” button remains illuminated for approx. 5 seconds during the system self-check after turning key in steering lock to position 2.

Emergency calls

An emergency call is initiated automatically following an accident in which the Emergency Tensioning Retractors (ETR’s) or airbags deploy. An emergency call can also be initiated manually by opening the cover next to the interior rear view mirror labeled “SOS”, then

Tele Aid

156

pressing the button (for longer than 2 seconds) located under the cover. See below for instructions on initiating an emergency call manually.

Once the emergency call is in progress, the indicator lamp in the “SOS” button will begin to flash. All information relevant to the emergency, such as the location of the vehicle (determined by the GPS satellite location system), vehicle model, identification number and color are generated.

A voice connection between the Response Center and the occupants of the vehicle will be established automatically soon after the emergency call has been initiated. The Response Center will attempt to determine more precisely the nature of the accident provided they can speak to an occupant of the vehicle.

The Tele Aid system is available if:

- it has been activated and is operational. Activation requires a subscription for monitoring services and cellular air time,
- the relevant cellular phone network and GPS signals are available.

Note:

Location of the vehicle on a map is possible if the vehicle is able to receive signals from the GPS satellite network.

Warning!

If the indicator lamp in the “SOS” button is illuminated continuously and there was no voice connection to the Response Center established, then the Tele Aid system could not initiate an emergency call (e.g. the relevant cellular phone network is not available).

Should this occur, assistance must be summoned by other means.

Initiating an emergency call

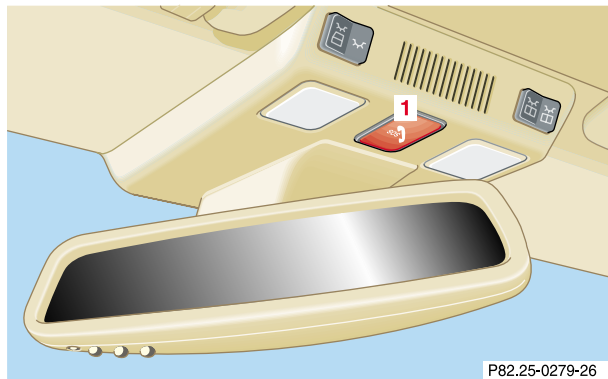

Manually:

Briefly press on cover (1) – the cover will open.

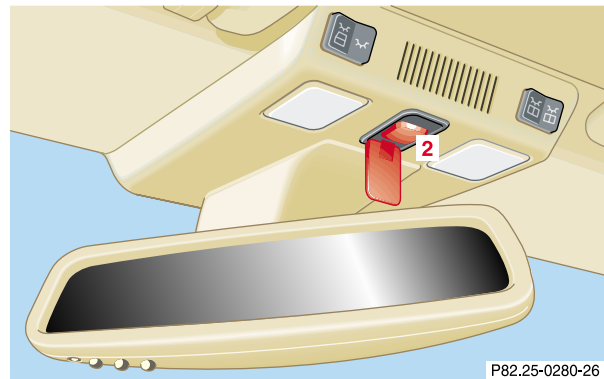

Press the emergency call switch (2) briefly (for longer than 2 seconds). The indicator lamp in the emergency call switch (2) will flash until the emergency call is concluded. Wait for a voice connection to the Response Center.

Close the cover (1) after the emergency call is concluded.

Warning!

If you feel at any way in jeopardy when in the vehicle (e.g. smoke or fire in the vehicle, vehicle in a dangerous road location), please do not wait for voice contact after you have pressed the emergency button. Carefully leave the vehicle and move to a safe location. The Response Center will automatically contact local emergency officials with the vehicle's approximate location if they receive an "SOS" signal and cannot make voice contact with the vehicle occupants.

Roadside Assistance button 



Located below the center armrest cover is the Roadside Assistance button . Pressing and holding the button (for longer than 2 seconds), will initiate a call to a Mercedes-Benz Roadside Assistance dispatcher. The button will flash while the call is in progress. The Tele Aid system will transmit data generating the vehicle identification number, model, color and location (subject to availability of cellular and GPS signals).

A voice connection between the Roadside Assistance dispatcher and the occupants of the vehicle will be established. The nature of the need for assistance can then be described. Sign and Drive services (jump start, a few gallons of fuel or the replacement of a flat tire with the vehicle spare tire) are available.

If the vehicle requires more than Sign and Drive services, the Mercedes-Benz Roadside assistance dispatcher will either dispatch a qualified Mercedes-Benz technician or arrange to tow your vehicle to the nearest Mercedes-Benz Center.

For other than Sign and Drive services, labor and/or towing charges may apply. Refer to the Roadside Assistance manual for more information.

Notes:

The indicator lamp in the Roadside Assistance button  remains illuminated in red for approx. 5 seconds during the system self-check after turning key in steering lock to position 2 (together with the "SOS" button and the Information button ).

See system self-check on page 155 when the indicator lamp does not light up in red or stays on longer than approximately 5 seconds.

Information button



Located below the center armrest cover is the Information button . Pressing and holding the button (for longer than 2 seconds), will initiate a call to the Client Assistance Center. The button will flash while the call is in progress. The Tele Aid system will transmit data generating the vehicle identification number, model, color and location (subject to availability of cellular and GPS signals).

A voice connection between the Client Assistance Center representative and the occupants of the vehicle will be established. Information regarding the operation of your vehicle, the nearest Mercedes-Benz Center or Mercedes-Benz USA products and services is available to you.

If you have chosen the Route Guidance Service (an optional service available at additional cost in the USA only), your communication will be transferred to our Response Center, who will provide the appropriate information.

For more details concerning this optional service, please contact the Response Center at 1-800-756-9018.

Notes:

The indicator lamp in the Information button  remains illuminated in red for approx. 5 seconds during the system self-check after turning key in steering lock to position 2 (together with the “SOS” button and the Roadside Assistance button ).

See system self-check on page 155 when the indicator lamp does not light up in red or stays on longer than approximately 5 seconds.

Important!

If the indicator lamps do not illuminate or remain illuminated (in red) at any time, the Tele Aid system has detected a fault or the service is not currently active, and may not initiate a call. Visit your Mercedes-Benz Center and have the system checked or contact the Response Center at 1-800-756-9018 (in the USA) or 1-888-923-8367 (in Canada) as soon as possible.

Tele Aid

160

Upgrade Signals

Tele Aid system processes calls using the following priority.

- Automatic emergency – First priority
- Manual emergency – Second priority
- Roadside assistance – Third priority
- Information – Fourth priority

Should a higher priority call be initiated while you are connected, an upgrade (alternating) tone will be heard, and the appropriate indicator lamp will flash. If certain information such as vehicle identification number or client information is not available, the operator may need to retransmit. During this time you will hear a chirp and voice contact will be interrupted. Voice contact will resume once the retransmission is complete. Once a call is concluded, a chirp will be heard, the appropriate indicator lamp will stop flashing and a tone will be heard indicating that the system has reset. The audio system operation will resume.

Important!

If the indicator lamp continues to flash or the system does not reset, contact the Response Center at 1-800-756-9018 (in the USA) or 1-888-923-8367 (in Canada), or Mercedes-Benz Client Assistance at 1-800-FOR-MERCEdes (1-800-367-6372) in the USA or Customer Service at 1-800-387-0100 in Canada.

Notes:

The indicator lamp in the respective button flashes until the call is concluded and this can only be completed by a Response Center or Client Assistance Center representative.

When a Tele Aid call has been initiated, the audio system is muted and the selected mode (radio, tape or CD) pauses. The optional cellular phone (if installed) switches off. If you must use this phone, the vehicle must be parked. Disconnect the coiled cord and place the call. A message will appear in the radio display to indicate that a Tele Aid call is in progress.

Remote door unlock

In the case you have your vehicle locked unintentionally (e.g. key inside vehicle), and the reserve key is not handy, contact the Mercedes-Benz Response Center at 1-800-756-9018 (in the USA) or 1-888-923-8367 (in Canada). You will be asked to provide your password which you provided when you completed the subscriber agreement.

Then return to your vehicle and press trunk lock for a minimum of 20 seconds.

The Response Center will then unlock your vehicle with the remote door unlocking feature.

Note:

The remote door unlock feature is available if the relevant cellular phone network and GPS signals are available.

Vehicle location/stolen vehicle tracking services

Should you wish to locate your vehicle, contact the Mercedes-Benz Response Center at 1-800-756-9018 (in the USA) or 1-888-923-8367 (in Canada). You will be asked to provide your password which you provided when you completed the subscriber agreement.

In the event your vehicle was stolen, report the incident to the police who will issue a numbered incident report. Pass this number on to the Mercedes-Benz Response Center.

The Response Center will then attempt to covertly contact the vehicle's Tele Aid system. The key in the steering lock must be in position 1 or 2 and the cellular and GPS signals must be available. The Response Center will contact you at the phone number(s) provided in the agreement once the vehicle is located. The Response Center will attempt to contact the vehicle until located, up to a maximum of 14 days or until the vehicle location incident report is cancelled by you.

Important!

Tele Aid utilizes the cellular network for communication and the GPS (Global Positioning System) satellites for vehicle location. If either of these signals are unavailable, the Tele Aid system may not function and if this occurs, assistance must be summoned by other means.

Warning!

The Tele Aid control unit is located under the driver's seat. If there is accumulation of water or other liquid in this area, the Tele Aid control unit could suffer an electrical short circuit making the system inoperative. In this case the indicator lamp in the "SOS" button does not illuminate during or remains illuminated after the system self-check. Have the system checked at the nearest Mercedes-Benz Center as soon as possible.

Catalytic converter

Your Mercedes-Benz is equipped with monolithic type catalytic converters, an important element in conjunction with the oxygen sensors to achieve substantial control of the pollutants in the exhaust emissions. Keep your vehicle in proper operating condition by following our recommended maintenance instructions as outlined in your Service Booklet.

Caution!

To prevent damage to the catalytic converters, use only premium unleaded gasoline in this vehicle.

Any noticeable irregularities in engine operation should be repaired promptly. Otherwise, excessive unburned fuel may reach the catalytic converter causing it to overheat, which could start a fire.

Warning!

As with any vehicle, do not idle, park or operate this vehicle in areas where combustible materials such as grass, hay or leaves can come into contact with the hot exhaust system, as these materials could be ignited and cause a vehicle fire.

Emission control

Certain systems of the engine serve to keep the toxic components of the exhaust gases within permissible limits required by law.

These systems, of course, will function properly only when maintained strictly according to factory specifications. Any adjustments on the engine should, therefore, be carried out only by qualified Mercedes-Benz authorized Center technicians. Engine adjustments should not be altered in any way. Moreover, the specified service jobs must be carried out regularly according to Mercedes-Benz servicing requirements. For details refer to the Service Booklet.

Warning!

Inhalation of exhaust gas is hazardous to your health. All exhaust gas contains carbon monoxide, and inhaling it can cause unconsciousness and lead to death.

Do not run the engine in confined areas (such as a garage) which are not properly ventilated. If you think that exhaust gas fumes are entering the vehicle while driving, have the cause determined and corrected immediately. If you must drive under these conditions, drive only with at least one window fully open.

Steering lock

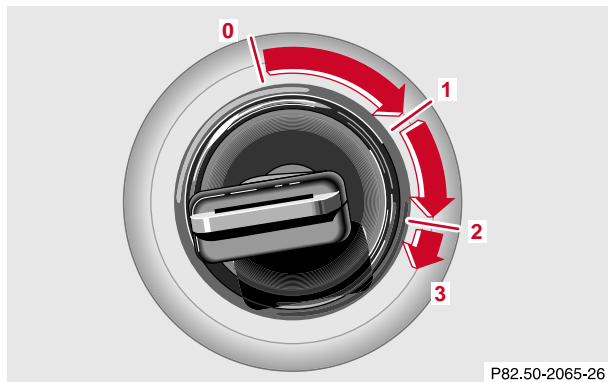

- 0 The key can be withdrawn in this position only. The steering is locked when the electronic key is removed from the steering lock. If necessary, move steering wheel slightly to allow the locking mechanism to engage.

The key can be removed only with your foot off the brake pedal and the selector level in position “P”. After removing the key or with the key in steering lock position 0, the selector lever is locked in position “P”.

- 1 Steering is unlocked.

(If necessary, move steering wheel slightly to allow the key to be turned clockwise to position 1.)

Most electrical consumers can be operated. For detailed information see respective subjects.

- 2 Driving position.
3 Starting position.

See page 167 for instructions on starting and stopping the engine.

Warning!

When leaving the vehicle always remove the key from the steering lock, and lock the vehicle. Do not leave children unattended in the vehicle, or with access to an unlocked vehicle. Unsupervised use of vehicle equipment may cause serious personal injury.

Steering lock

166

Notes:

A warning sounds when the driver's door is opened while the key is in steering lock position 1 or 0.

With the engine at idle speed, the charging rate of the alternator (output) is limited.

It is therefore recommended that you turn off unnecessary electrical consumers while driving in stop-and-go traffic. This precaution helps to avoid draining of the battery.

Unnecessary strain on the battery and charging system may be minimized by turning off the following power consumers, for example: Heated seats, rear window defroster.

Caution!

To prevent accelerated battery discharge and a possible dead battery, always remove the key from the steering lock. **Do not** leave the key in steering lock position 0.

Starting and turning off the engine

Before starting

Ensure that parking brake is engaged and that selector lever is in position “P” or “N”. Turn key in steering lock to position 2.

Starting

Do not depress accelerator. Briefly turn key in steering lock clockwise to the stop and release. The starter will engage until the engine is running.

If engine will not run, and the starting procedure stops, turn key completely to the left and repeat starting the engine.

After several unsuccessful attempts, have the system checked at the nearest authorized Mercedes-Benz Center.

Important!

Due to the installed starter nonrepeat feature, the key must be turned completely to the left before attempting to start the engine again.

In areas where temperatures frequently drop below -4°F (-20°C) we recommend that an engine block heater be installed. Your authorized Mercedes-Benz Center will advise you on this subject.

Turning off

Turn the key in the steering lock to position 0 to stop the engine.

Vehicles with automatic transmission:

The key can only be removed with your foot off the brake pedal and the selector lever in position “P”.

Automatic transmission

168

Automatic transmission

The automatic transmission selects individual gears automatically, dependent upon

- Selector lever position
- Program mode selector
- Accelerator position
- Vehicle speed

The gear shifting process is continuously adapted, dependent on the driving style, the driving situation and the road characteristics.

Important!

When parking the car or before working on the vehicle with the engine running, firmly engage the parking brake and shift the selector lever into “P”.

Driving

The selector lever is automatically locked while in position “P”. To move the selector lever out of position “P”, the service brake pedal must be firmly depressed before the shift lock will release.

Shift selector lever to the desired position only when the engine is idling normally and the service brake is applied. Do not release the brake until ready to drive. The vehicle may otherwise start creeping when the selector lever is in drive or reverse position.

Warning!

It is dangerous to shift the selector lever out of “P” or “N” if the engine speed is higher than idle speed. If your foot is not firmly on the brake pedal, the vehicle could accelerate quickly forward or in reverse. You could lose control of the vehicle and hit someone or something. Only shift into gear when the engine is idling normally and when your right foot is firmly on the brake pedal.

Important!

After selecting any driving position from “N” or “P”, wait a moment to allow the gear to fully engage before accelerating, especially when the engine is cold.

Accelerator Position

Partial throttle = early upshifting = normal acceleration

Full throttle = later upshifting = rapid acceleration

Kickdown (depressing the accelerator beyond full throttle) = downshifting to a lower gear = maximum acceleration. Once the desired speed is attained, ease up on the accelerator – the transmission shifts up again.

Selector lever positions

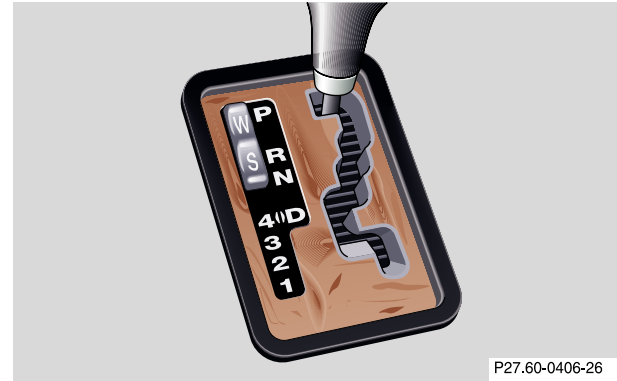

The automatic gear shifting process can be adapted to specific operating conditions using the selector lever.

Automatic transmission

170

P Park position

The park position is to be used when parking the vehicle. Engage only with the vehicle stopped. The park position is not intended to serve as a brake when the vehicle is parked. Rather, the driver should always use the parking brake in addition to placing the selector lever in park to secure the vehicle.

Note:

The key can be removed from the steering lock only with the foot off the brake pedal and the selector lever in position “P”. With the key removed, the selector lever is locked in position “P”.

R Reverse gear

Shift to reverse gear only with the vehicle stopped.

Depending on the program mode selector switch position “S” or “W” the maximum speed in the reverse gear is different. However, it is not possible to change the program mode while in reverse.

N Neutral

No power is transmitted from the engine to the drive axle. When the brakes are released, the vehicle can be moved freely (pushed or towed). Do not engage “N” while driving except to coast when the vehicle is in danger of skidding (e.g. on icy roads, see page 182).

Important!

Coasting the vehicle, or driving for any other reason with selector lever in “N” can result in transmission damage that is not covered by the Mercedes-Benz Limited Warranty.

D The transmission automatically upshifts through 5th gear. Position “D” provides optimum driving characteristics under all normal operating conditions.

4 Upshift through 4th gear only. Suitable for performance driving. To shift from position “D” to “4”, push selector lever to the left.

3 Upshift through 3rd gear only. Suitable for moderately steep hills. Since the transmission does not shift higher than 3rd gear, this gear selection will allow use of the engine’s braking power downhill.

2 Upshift through 2nd gear only. For driving in mountainous regions or under extreme operating conditions. This gear selection will allow use of the engine's braking power when descending steep grades.

1 Use this position, which makes maximum use of the engine's braking effect, while descending very steep or lengthy downgrades and only at speeds below 40 mph (60 km/h).

Important!

With selector lever in position "D", "4" or "3", upshifting from 1st to 2nd to 3rd gear is delayed depending on vehicle speed and engine temperature. This allows the catalytic converter to heat up more quickly to operating temperatures.

During the brief warm-up period this delayed upshift and increased engine noise might be perceived as a malfunction. However, neither the engine nor transmission are negatively affected by this mode of operation.

The delayed upshift is effective with vehicle speeds below 31 mph (50 km/h) at partial throttle and engine temperatures below 95°F (35°C).

To avoid overrevving the engine when the selector lever is moved to a lower driving range, the transmission will not shift to a lower gear, if the engine's speed limit would be exceeded. In this case there will be no downshift, even when the vehicle speed reaches the engine's speed limit of that gear, e.g. by applying the service brakes. Continue driving in the usual manner. The transmission will then shift down automatically.

To prevent the engine from laboring at low RPM when driving uphill gradients or with your vehicle heavily loaded, the automatic transmission will downshift when necessary to maintain engine RPM within the best torque range.

Warning!

On slippery road surfaces, never downshift in order to obtain braking action. This could result in drive wheel slip and reduced vehicle control. Your vehicle's ABS will not prevent this type of loss of control.

Automatic transmission

172

Maneuvering

To maneuver in tight areas, e.g. when pulling into a parking space, control the vehicle speed by gradually releasing the brakes. Accelerate gently and never abruptly step on the accelerator.

To rock a vehicle out of soft ground (mud or snow), alternately shift from forward to reverse, while applying only slight partial throttle.

Rocking a vehicle free in this manner may cause the ABS malfunction indicator lamp to come on. Turn off and restart the engine to clear the malfunction indication.

Stopping

For brief stops, e.g. at traffic lights, leave the transmission in gear and hold vehicle with the service brake.

For longer stops with the engine idling, shift into "N" or "P" and hold the vehicle with the service brake.

When stopping the vehicle on an uphill gradient, do not hold it with the accelerator, use the brake. This avoids unnecessary transmission heat build up.

Warning!

Getting out of your vehicle with the selector lever not fully engaged in position "P" is dangerous. Also, when parked on an incline, position "P" alone may not prevent your vehicle from moving, possibly hitting people or objects.

Always set the parking brake in addition to shifting to position "P".

When parked on an incline, also turn front wheel towards the road curb.

Program mode selector switch

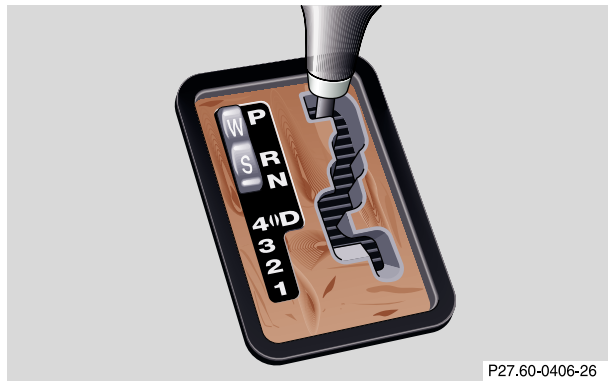

The transmission is provided with a selector switch for Standard “S” and Winter/Wet (snow and ice) “W” program modes.

Caution!

Never change the program mode when the selector lever is out of position “P”. It could result in a change of driving characteristics for which you may not be prepared.

Important!

Always be certain of the program mode selected since the vehicle driving characteristics change with the selection of the program mode.

S Standard mode

Press switch on symbol “S”. Use this mode for all regular driving.

The vehicle starts out in 1st gear.

Accelerator Operation:

Fast on = depressing the accelerator pedal quickly (not into kickdown position) while driving continuously, rather than depressing the accelerator pedal in the usual manner, will cause the automatic transmission to shift down into a lower gear. This gear shifting process is dependent on the current vehicle speed.

Fast off = there will be no upshift when releasing the accelerator pedal quickly, e.g. using the engine’s braking power during performance driving.

Automatic transmission

174

W Winter/Wet (snow and ice) mode

Press switch on symbol "W". The vehicle starts out in 2nd gear, except with selector lever in 1st gear, or with accelerator pedal in kick-down position.

The "W" mode helps to improve traction and driving stability of the vehicle.

The gear shifting process occurs at lower vehicle and engine speeds than in the "S" program mode.

Important!

Dependent on the program mode selector switch position "S" or "W" and the gear selector lever in position "R", the ratio of power transmission changes.

**Emergency operation
(Limp Home Mode)**

If vehicle acceleration worsens, or the transmission no longer shifts, the transmission is most likely operating in Limp Home Mode which engages when there is a malfunction of the transmission. This condition may be accompanied by the "CHECK ENGINE" malfunction indicator lamp in the instrument cluster coming on.

In this mode only the 2nd gear or reverse gear can be activated.

To engage 2nd gear or reverse:

1. Stop the vehicle.
2. Move selector lever to position "P".
3. Turn off the engine.
4. Wait approx. 10 seconds.
5. Restart the engine.
6. Move selector lever to position "D" (for 2nd gear), or move selector lever to position "R" (for reverse gear).

Have the transmission checked at your authorized Mercedes-Benz Center as soon as possible.

Parking brake



To engage, firmly depress parking brake pedal. When the key is in steering lock position 2, the brake warning lamp in the instrument cluster should come on brightly.

To release the parking brake, pull handle on instrument panel. The brake warning lamp in the instrument cluster should go out.

A warning sounds, if you start to drive without having released the parking brake.

Also see brake warning lamp test on page 204.

Warning!

When leaving the vehicle always remove the electronic key from the steering lock, and lock the vehicle. Do not leave children unattended in the vehicle, or with access to an unlocked vehicle. Children could release the parking brake, which could result in an accident or serious injury.

Driving instructions

Drive sensibly - Save fuel

Fuel consumption, to a great extent, depends on driving habits and operating conditions.

To save fuel you should:

- keep tires at the recommended inflation pressures,
- remove unnecessary loads,
- allow engine to warm up under low load use,
- avoid frequent acceleration and deceleration,
- have all maintenance work performed at regular intervals by an authorized Mercedes-Benz Center.

Fuel consumption is also increased by driving in cold weather, in stop-and-go traffic, on short trips and in hilly country.

Drinking and driving

Warning!

Drinking or taking drugs and driving can be a very dangerous combination. Even a small amount of alcohol or drugs can affect your reflexes, perceptions and judgement.

The possibility of a serious or even fatal accident is sharply increased when you drink or take drugs and drive.

Please don't drink or take drugs and drive or allow anyone to drive after drinking or taking drugs.

Pedals

Warning!

Keep driver's foot area clear at all times. Objects stored in this area may impair pedal movement.

Power assistance

Warning!

When the engine is not running, the brake and steering systems are without power assistance. Under these circumstances, a much greater effort is necessary to stop or steer the vehicle.

Brakes

Warning!

After driving in heavy rain for some time without applying the brakes or through water deep enough to wet brake components, the first braking action may be somewhat reduced and increased pedal pressure may be necessary to obtain expected braking effect. Be sure to maintain a safe distance from vehicles in front.

Resting your foot on the brake pedal will cause excessive and premature wear of the brake pads.

It can also result in the brakes overheating thereby significantly reducing their effectiveness. It may not be possible to stop the vehicle in sufficient time to avoid an accident.

The condition of the parking brake system is checked each time the vehicle is in the shop for the required maintenance service.

If the parking brake is released and the brake warning lamp in the instrument cluster stays on, the brake fluid level in the reservoir is too low.

Brake pad wear or a leak in the system may be the reason for low brake fluid in the reservoir.

Have the brake system inspected at an authorized Mercedes-Benz Center immediately.

All checks and service work on the brake system should be carried out by an authorized Mercedes-Benz Center.

Install only brake pads and brake fluid recommended by Mercedes-Benz.

Warning!

If other than recommended brake pads are installed, or other than recommended brake fluid is used, the braking properties of the vehicle can be degraded to an extent that safe braking is substantially impaired. This could result in an accident.

The trunk is the preferred place to carry objects.

Caution!

When driving down long and steep grades, relieve the load on the brakes by shifting into a lower gear to use the engine's braking power. This helps prevent overheating of the brakes and reduces brake pad wear.

After hard braking, it is advisable to drive on for some time, rather than immediately parking, so the air stream will cool down the brakes faster.

Driving off

Apply the service brakes to test them briefly after driving off. Perform this procedure only when the road is clear of other traffic.

Warm up the engine smoothly. Do not place full load on the engine until the operating temperature has been reached.

When starting off on a slippery surface, do not allow one drive wheel to spin for an extended period with the ESP switched off. Doing so may cause serious damage to the drive train which is not covered by the Mercedes-Benz Limited Warranty.

Parking**Warning!**

To reduce the risk of personal injury as a result of vehicle movement, before turning off the engine and leaving the vehicle always:

1. **Keep right foot on the service brake pedal.**
2. **Firmly engage parking brake.**
3. **Move the selector lever to position "P"**
4. **Slowly release the service brake pedal.**
5. **Turn front wheels towards the road curb.**
6. **Turn the key to steering lock position 0 and remove.**
7. **Take the key and lock vehicle when leaving.**

Important!

Always engage the parking brake whenever parking or leaving the vehicle. In addition, move selector lever to position "P".

When parking on hills, always set the parking brake.

Tires

Warning!

If you feel a sudden significant vibration or ride disturbance, or you suspect that possible damage to your vehicle has occurred, you should turn on the hazard warning flashers, carefully slow down, and drive with caution to an area which is a safe distance from the roadway.

Inspect the tires and under the vehicle for possible damage. If the vehicle or tires appear unsafe, have it towed to the nearest Mercedes-Benz Center or tire dealer for repairs.

Tread wear indicators (TWI) are required by law. These indicators are located in six places on the tread circumference and become visible at a tread depth of approximately $\frac{1}{16}$ in (1.5 mm), at which point the tire is considered worn and should be replaced.

The tread wear indicator appears as a solid band across the tread.

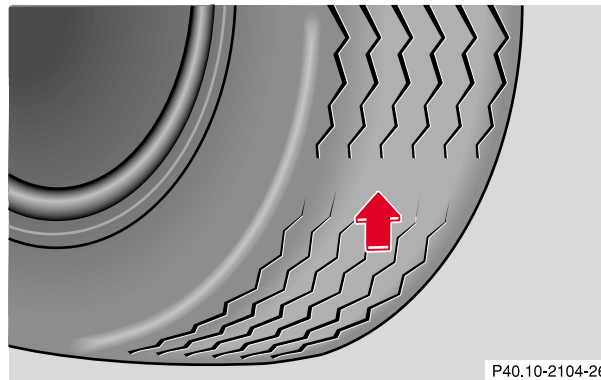

Warning!

Do not allow your tires to wear down too far. As tread depth approaches $\frac{1}{16}$ in (1.5 mm), the adhesion properties on a wet road are sharply reduced.

Depending upon the weather and/or road surface (conditions), the tire traction varies widely.

Driving instructions

180

Specified tire pressures must be maintained. This applies particularly if the tires are subjected to high loads (e.g. high speeds, heavy loads, high ambient temperatures).

Warning!

Do not drive with a flat tire. A flat tire affects the ability to steer or brake the vehicle. You may lose control of the vehicle. Continued driving with a flat tire or driving at high speed with a flat tire will cause excessive heat build-up and possibly a fire.

Aquaplaning

Depending on the depth of the water layer on the road, aquaplaning may occur, even at low speeds and with new tires. Reduce vehicle speed, avoid track grooves in the road and apply brakes cautiously in the rain.

Tire traction

The safe speed on a wet, snow covered or icy road is always lower than on a dry road.

You should pay particular attention to the condition of the road whenever the outside temperatures are close to the freezing point.

Warning!

If ice has formed on the road, tire traction will be substantially reduced. Under such weather conditions, drive, steer and brake with extreme caution.

We recommend M+S rated radial-ply tires for the winter season for all four wheels to insure normal balanced handling characteristics. On packed snow, they can reduce your stopping distance as compared with summer tires. Stopping distance, however, is still considerably greater than when the road is not snow or ice covered.

Tire speed rating

Vehicles without Sport Package:

Your vehicle is factory equipped with “W”-rated tires, which have a speed rating of 168 mph (270 km/h).

Vehicles with Sport Package:

Your vehicle is factory equipped with “V”-rated tires, which are permissible for speeds over 149 mph (240 km/h).

Despite the tire rating, local speed limits should be obeyed. Use prudent driving speeds appropriate to prevailing conditions.

Warning!

Even when permitted by law, never operate a vehicle at speeds greater than the maximum speed rating of the tires.

Exceeding the maximum speed for which tires are rated can lead to sudden tire failure causing loss of vehicle control and resulting in personal injury and possible death.

Snow chains

Use only snow chains that are tested and recommended by Mercedes-Benz. Your authorized Mercedes-Benz Center will be glad to advise you on this subject.

Chains should only be used on the rear wheels. Follow the manufacturer’s mounting instructions.

Snow chains should only be driven on snow covered roads at speeds not to exceed 30 mph (50 km/h). Remove chains as soon as possible when driving on roads without snow.

When driving with snow chains, press the ESP control switch to OFF, see page 194.

Vehicles with Sport Package

Use of snow chains is not permissible with tire sizes 245/40 ZR 18 or 275/35 ZR 18.

Winter driving instructions

The most important rule for slippery or icy roads is to drive sensibly and to avoid abrupt acceleration, braking and steering maneuvers. Do not use the cruise control system under such conditions.

When the vehicle is in danger of skidding, move selector lever to position "N". Try to keep the vehicle under control by corrective steering action.

Road salts and chemicals can adversely affect braking efficiency. Increased pedal force may become necessary to produce the normal brake effect. We therefore recommend depressing the brake pedal periodically when traveling at length on salt-strewn roads. This can bring road salt impaired braking efficiency back to normal. A prerequisite is, however, that this be done without endangering other drivers on the road.

If the vehicle is parked after being driven on salt treated roads, the braking efficiency should be tested as soon as possible after driving is resumed while observing the safety rules in the previous paragraph.

Warning!

If the vehicle becomes stuck in snow, make sure that snow is kept clear of the exhaust pipe and from around the vehicle with engine running. Otherwise, deadly carbon monoxide (CO) gases may enter vehicle interior resulting in unconsciousness and death.

To assure sufficient fresh air ventilation, open a window slightly on the side of the vehicle not facing the wind.

Winter driving

Have your vehicle winterized at your authorized Mercedes-Benz Center before the onset of winter.

- Change the engine oil if the engine contains an oil which is not approved for winter operation. For viscosity (SAE/CCMC class) and filling quantity, see page 276.
- Check engine coolant anticorrosion/antifreeze concentration.
- Additive for the windshield washer and headlamp cleaning system: Add MB Concentrate “S” to a premixed windshield washer solvent/antifreeze which is formulated for below freezing temperatures, see page 88.
- Test battery: Battery capacity drops with decreasing ambient temperature. A well charged battery helps to ensure that the engine can be started, even at low ambient temperatures.
- Tires: We recommend M+S rated radial-ply tires on all four wheels for the winter season. Observe permissible maximum speed for M+S rated radial-ply tires and the legal speed limit.

Note:

In winter operation, the maximum effectiveness of the antilock brake system (ABS) or electronic stability program (ESP) can only be achieved with M+S rated radial-ply tires and/or snow chains recommended by Mercedes-Benz. Snow chains maximize performance.

Block heater (for Canada only)

The engine is equipped with a block heater.

The electrical cable may be installed at your authorized Mercedes-Benz Center.

Driving instructions

184

Deep water**Caution!**

Do not drive through flooded areas or water of unknown depth.

If you must drive through deep water, drive slowly to prevent water from entering the engine compartment or passenger compartment, being ingested by the air intake, possibly causing damage to electrical components or wiring, to engine or transmission that is not covered by the Mercedes-Benz Limited Warranty.

Traveling abroad

Abroad, there is a widely-spread Mercedes-Benz service network at your disposal. If you plan to travel into areas which are not listed in the index of your Center directory, you should request pertinent information from your authorized Mercedes-Benz Center.

Cruise control

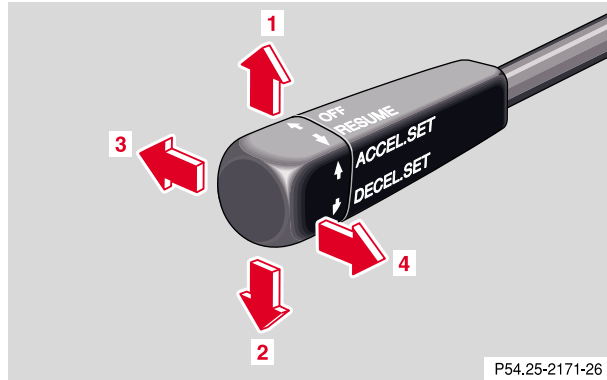

The cruise control allows you to drive in a more relaxed manner, for example over long distances, as it automatically maintains the set speed by actively regulating the throttle setting.

Any given speed above approximately 25 mph (40 km/h) can be maintained with the cruise control by operating the lever.

- 1 Accelerate and set:**
Lift lever briefly to set speed. Hold lever up to accelerate.
- 2 Decelerate and set:**
Depress lever briefly to set speed. Hold lever down to decelerate.

Normally the vehicle is accelerated to the desired speed with the accelerator.

Speed is set by briefly pushing the lever to position 1 or 2. The accelerator can then be released.

The speed can be increased (e.g. for passing) by using the accelerator. After the accelerator is released, the previously set speed will be resumed automatically.

Driving systems

186

If a set speed is to be increased or decreased slightly, e. g. to adapt to the traffic flow, hold lever in position 1 or 2 until the desired speed is reached, or briefly tip the lever in the appropriate direction for increases or decreases in 0.6 mph (1 km/h) increments. When the lever is released, the newly set speed remains.

3 Canceling

To cancel the cruise control, briefly push lever to position 3.

When you step on the brake pedal or the vehicle speed drops below approx. 25 mph (40 km/h), for example when driving upgrade, the cruise control will be canceled.

If the cruise control cancels by itself and remains inoperative until the engine is restarted, have the system checked at your authorized Mercedes-Benz Center as soon as possible.

4 Resume

If the lever is briefly pushed to position 4 when driving at a speed exceeding approx. 25 mph (40 km/h), the vehicle resumes the speed which was set prior to the cancellation of the cruise control. The last memorized speed is canceled when the key in the steering lock is turned to position 1 or 0.

Important!

Moving gear selector lever to position “N” switches the cruise control off.

Warning!

Only use the cruise control if the traffic and weather conditions make it advisable to travel at a steady speed.

- **The use of cruise control can be dangerous on winding roads or in heavy traffic because conditions do not allow safe driving at a steady speed.**

- **The use of cruise control can be dangerous on slippery roads. Rapid changes in tire adhesion can result in wheel spin and loss of control.**

The “Resume” function should only be operated if the driver is fully aware of the previously set speed and wishes to resume this particular preset speed.

Notes:

If the engine does not brake the vehicle sufficiently while driving on a downgrade, the speed you set on the cruise control may be exceeded. In this case the automatic transmission shifts down (max. to 3rd gear) to maintain the set cruise control speed by using the engine’s braking power.

As soon as the grade eases, the automatic transmission shifts up again dependent on the selector lever position.

Nevertheless, in some cases you may have to step on the brake pedal to slow down. In this case the cruise control is switched off.

Use the lever to resume the previously set speed.

Brake assist system (BAS)**Warning!**

BAS cannot prevent the natural laws of physics from acting on the vehicle, nor can it increase braking efficiency beyond that afforded by the condition of the vehicle brakes and tires or the traction afforded. The BAS cannot prevent accidents, including those resulting from excessive speed in turns, following another vehicle too closely, or aquaplaning. Only a safe, attentive, and skillful driver can prevent accidents. The capabilities of a BAS equipped car must never be exploited in a reckless or dangerous manner which could jeopardize the user's safety or the safety of others.

The BAS is designed to maximize the vehicle's braking capability during emergency braking maneuvers by having maximum power boost applied to the brakes more quickly in emergency braking conditions than might otherwise be afforded solely by the driver's braking style. This can help reduce braking distances over what ordinary driving and braking style might do. The BAS complements the antilock brake system (ABS).

Applying the brakes very quickly results in maximum BAS assistance.

To receive the benefit of the system you must apply continuous full braking power during the stopping sequence. Do not reduce brake pedal pressure.

Once the brake pedal is released, the BAS is deactivated.

The malfunction indicator lamps for the ESP are combined with the BAS malfunction indicator lamp.

The BAS/ESP malfunction indicator lamps in the instrument cluster come on with the key in steering lock position 2 and should go out with the engine running.

If the BAS/ESP malfunction indicator lamp comes on permanently while the engine is running, a malfunction has been detected in either system. As a result, it is possible that now only partial engine output will be available, and pressing the accelerator pedal will require more effort. If the BAS malfunctions, the brake system functions in the usual manner, but without BAS.

If the charging voltage falls below 10 volts, the malfunction indicator lamp comes on and the BAS is switched off. When the voltage is above this value again, the malfunction indicator lamp should go out and the BAS is operational.

With the ABS malfunctioning, the BAS and ESP is also switched off. Both malfunction indicator lamps come on with the engine running.

If a BAS warning message is displayed, have the BAS and ESP checked at your authorized Mercedes-Benz Center as soon as possible.

Antilock brake system (ABS)**Warning!**

Do not pump the brake pedal, rather use firm, steady brake pedal pressure. Pumping the brake pedal defeats the purpose for ABS and significantly reduces braking effectiveness.

Important!

The ABS improves steering control of the vehicle during hard braking maneuvers.

The ABS prevents the wheels from locking up above a vehicle speed of approximately 5 mph (8 km/h) independent of road surface conditions.

At the instant one of the wheels is about to lock up, a slight pulsation can be felt in the brake pedal, indicating that the ABS is in the regulating mode. Keep firm and steady pressure on the brake pedal while experiencing the pulsation.

Continuous steady brake pedal pressure results in applying the advantages of the ABS, namely braking power and ability to steer the vehicle.

In the case of an emergency brake maneuver keep continuous full pressure on the brake pedal. In this manner only can the ABS be most effective.

On slippery road surfaces, the ABS will respond even with light brake pedal pressure because of the increased likelihood of locking wheels. The pulsating brake pedal can be an indication of hazardous road conditions and functions as a reminder to take extra care while driving.

ABS control

The ABS malfunction indicator lamp  in the instrument cluster comes on with the key in steering lock position 2 and should go out with the engine running.

When the ABS malfunction indicator lamp symbol and warning in the instrument cluster comes on while the engine is running, it indicates that the ABS has detected a malfunction and has switched off. In this case, the brake system functions in the usual manner, but without antilock assistance.

With the ABS malfunctioning, the BAS and ESP are also switched off. Both malfunction indicator lamps come on with the engine running.

If the charging voltage falls below 10 volts, the malfunction indicator lamp comes on and the ABS is switched off. When the voltage is above this value again, the malfunction indicator lamp should go out and the ABS is operational.

If the ABS malfunction indicator light stays illuminated, have the system checked at your authorized Mercedes-Benz Center as soon as possible.

Warning!

ABS cannot prevent the natural laws of physics from acting on the vehicle, nor can it increase the traction made available by the road conditions. The ABS cannot prevent accidents, including those resulting from excessive speed in turns, following another vehicle too closely, or aquaplaning. Only a safe, attentive, and skillful driver can prevent accidents. The capabilities of an ABS equipped vehicle must never be exploited in a reckless or dangerous manner which could jeopardize the user's safety or the safety of others.

Note:

To alert following vehicles to slippery road conditions you discover, operate your hazard warning flashers as appropriate.

Electronic stability program (ESP)

Warning!

ESP cannot prevent the natural laws of physics from acting on the vehicle, nor can it increase the traction afforded. The ESP cannot prevent accidents, including those resulting from excessive speed in turns, or aquaplaning. Only a safe, attentive, and skillful driver can prevent accidents. The capabilities of an ESP equipped vehicle must never be exploited in a reckless or dangerous manner which could jeopardize the user's safety or the safety of others.

The ESP enhances directional control and reduces driving wheel spin of the vehicle under various driving conditions.

Over/understeering of the vehicle is counteracted by applying brakes to the appropriate wheel to create a countervailing vehicle movement. Engine torque is also limited. The ESP warning lamp, located in the speedometer dial, starts to flash when ESP is in operation.

Important!

If the ESP warning lamp  flashes:

- During take-off apply as little throttle as possible.
- While driving ease up on the accelerator.
- Adapt your speed and driving to the prevailing road conditions.
- Do not switch off the ESP.

Caution!

If the vehicle is towed with the front axle raised (see page 240), the engine must be shut off (key in steering lock position 0 or 1). Otherwise, the ESP will immediately be engaged and will apply the rear wheel brakes.

Notes:

The malfunction indicator lamp for the ESP is combined with that of the BAS.

The yellow BAS/ESP malfunction indicator lamp in the instrument cluster and the yellow ESP warning lamp  in the speedometer dial come on with the key in steering lock position 2. They should go out with the engine running.

If the BAS/ESP malfunction indicator lamp comes on permanently with the engine running, a malfunction has been detected in either system. Pressing the accelerator pedal will require greater effort. Only partial engine output will be available.

If the BAS malfunctions, the brake system functions in the usual manner, but without BAS.

If the BAS/ESP malfunction indicator lamp comes on, have the BAS or ESP checked at your authorized Mercedes-Benz Center as soon as possible.

With the ABS malfunctioning, the ESP is also switched off.

Driving the vehicle with varied size tires will cause the wheels to rotate at different speeds, therefore the ESP may activate (yellow ESP warning lamp in speedometer dial comes on). For this reason, all wheels, including the spare wheel, must have the same tire outside diameter.

When testing the parking brake on a brake test dynamometer, the engine must be shut off. Otherwise, the ESP will immediately be engaged and will apply the rear wheel brakes.

In winter operation, the maximum effectiveness of the ESP is only achieved with Mercedes-Benz recommended M+S rated radial-ply tires and/or snow chains.

Synchronizing ESP

If the power supply was interrupted (battery disconnected or empty), the BAS/ESP malfunction indicator lamp may be illuminated with the engine running.

Turn steering wheel completely to the left and then to the right. The BAS/ESP malfunction indicator lamp should go out.

ESP control switch

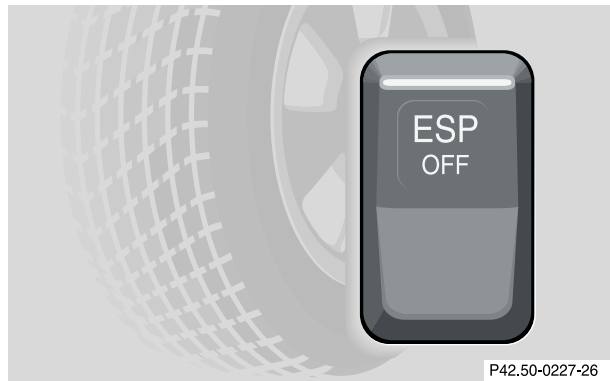

ESP control switch located in center console.

To improve the vehicle's traction when driving with snow chains, or starting off in deep snow, sand or gravel, switch off ESP by pressing the upper half of the ESP switch. The ESP warning lamp  located in the speedometer dial, is continuously illuminated.

Warning!

When the ESP warning lamp is illuminated continuously, the ESP is switched off.

Adapt your speed and driving to the prevailing road conditions.

With the ESP system switched off, the engine torque reduction feature is cancelled. Therefore, the enhanced vehicle stability offered by ESP is unavailable.

Adapt your speed and driving to the prevailing road conditions.

A portion of the ESP system remains active, even with the switch in the OFF position.

If one drive wheel loses traction and begins to spin, the brake is applied until the wheel regains sufficient traction. The traction control engages at vehicle speeds up to approximately 24 mph (40 km/h), and switches off at 50 mph (80 km/h).

Note:

Avoid spinning of one drive wheel. This may cause serious damage to the drive train which is not covered by the Mercedes-Benz Limited Warranty.

The ESP warning lamp, located in the speedometer dial, starts to flash at any vehicle speed as soon as the tires lose traction and the wheels begin to spin.

To return to the enhanced vehicle stability offered by ESP: press lower half of the switch (the ESP warning lamp in the speedometer dial goes out).

Important!

If the ESP warning lamp flashes:

- during take-off, apply as little throttle as possible,
- while driving, ease up on the accelerator.

Driving systems

196

Level control system
(SL 600 only)

The switch is located next to the exterior lamp switch

- 1** Level control switch
- 2** Wheel change switch

Level control switch positions

Press upper half of switch once for option 1. One indicator lamp lights up.

Press upper half of switch twice for option 2. Both indicator lamps light up.

Note:

The indicator lamps blink at first, and stay on continuously once the selected level is attained.

Press lower half of switch once:

From option 2, system switches to option 1. Only one indicator lamp is illuminated.

From option 1, system returns to Normal Level. Indicator lamp goes out.

Press lower half of switch twice:

From option 2, system returns to Normal Level. Both indicator lamps go out.

Normal level

Used for normal operation of the vehicle.

At speeds above approximately 60 mph (95 km/h) the vehicle chassis is lowered automatically by about one half inch (15 mm).

Option 1

Level increases one half inch (15 mm)

This setting may be used when road surface conditions are rough.

When option 1 is selected, the vehicle chassis is raised by one half inch (15 mm) at vehicle speeds up to approx. 35 mph (60 km/h).

At speeds between approximately 35 mph (60 km/h) and 60 mph (95 km/h) the vehicle chassis is lowered to its normal level.

At speeds above approximately 60 mph (95 km/h) the vehicle chassis is lowered an additional one half inch (15 mm).

Notes:

When exceeding approximately 60 mph (95 km/h), the system switches from option 1 back to Normal Level. The indicator lamp will go out.

If speed exceeds 35 mph (60 km/h) but does not exceed 60 mph (95 km/h), the vehicle chassis will be automatically raised again by one half inch (15 mm) when vehicle speed drops below approx. 35 mph (60 km/h).

Option 2

Level increases one inch (30 mm)

This setting may be used when road surface conditions are very rough for increased ground clearance.

Upon selection of option 2 the vehicle chassis is raised by one inch (30 mm). This option can only be selected at vehicle standstill, and the raised level is only retained up to speeds of approximately 15 mph (25 km/h).

At speeds between approximately 15 mph (25 km/h) and 35 mph (60 km/h) the vehicle chassis is lowered by one half inch (15 mm).

Driving systems

198

At speeds between approximately 35 mph (60 km/h) and 60 mph (95 km/h) the vehicle chassis is lowered to its normal level.

At speeds above approximately 60 mph (95 km/h) the vehicle chassis is lowered an additional one half inch (15 mm).

Notes:

When exceeding approximately 35 mph (60 km/h), the system will switch from option 2 to option 1. Only one indicator lamp will be illuminated.

When exceeding approximately 60 mph (95 km/h) the system will switch from option 1 to Normal Level. The indicator lamp will go out.

If speed exceeds approx. 35 mph (60 km/h) but does not exceed 60 mph (95 km/h), the system will switch from option 2 to option 1 when vehicle speeds drop below approximately 35 mph (60 km/h).

If speed does not exceed 35 mph (60 km/h), the system will switch from option 2 to option 1 when driving on after the vehicle has been stopped.

Wheel change switch (2)

Prior to changing a wheel, depress wheel change switch with engine running. The indicator lamp in the switch and ADS malfunction indicator lamp light up. The presently selected level option cannot be changed now. After activating the wheel change switch turn off the engine.

Warning!

Do not drive the vehicle while the wheel change switch is activated since the vehicle suspension will not function properly.

Adaptive Damping System (ADS) (SL 600 only)

Depending upon road surface conditions, load, driving style, ADS will automatically adjust the optimal ride firmness.

The malfunction indicator lamp comes on with the key in steering lock position 2 and should go out with the engine running.

If the malfunction indicator lamp stays on after the engine is running or comes on while driving, then the system has detected a malfunction.

Have the ADS checked at your authorized Mercedes-Benz Center as soon as possible.

Note:

If the power supply was interrupted (battery disconnected or empty), the malfunction indicator lamp will light up when the engine is running.

Turn the steering wheel from full left to full right lock position. The light should go out.

Adaptive damping system adjustment

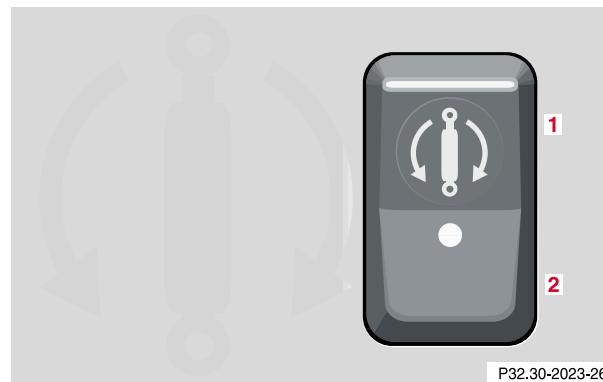

The switch is located in the center console.

- 1** Firm dampening program. This setting should be used for sporty driving. During the setting for sporty driving the indicator lamp in the switch lights up.
- 2** Soft dampening program. This setting should be used for regular driving.

What you should know at the gas station

200

What you should know at the gas station

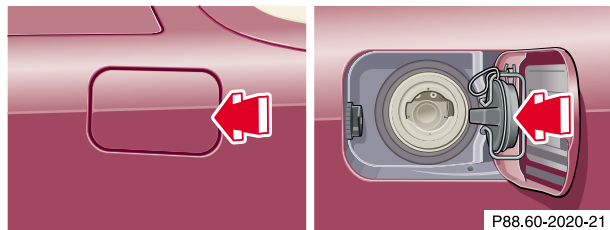

Fuel supply

Open flap by pushing near front (arrow). Turn fuel cap to the left and hold on to it until possible pressure in tank has been released, then remove cap. Failure to remove slowly could result in personal injury.

Warning!

Gasoline is highly flammable and poisonous. It burns violently and can cause serious injury. Whenever you are around gasoline, avoid inhaling fumes and skin contact, extinguish all smoking materials. Never allow sparks, flame or smoking materials near gasoline!

Fuel

To prevent fuel vapors from escaping into open air, fully insert filler nozzle unit.

Only fill fuel tank until the filler nozzle unit cuts out – do not top up or overfill.

Warning!

Overfilling of fuel tank may result in creating pressure in the system which could cause a gas discharge such as the gas spraying back out upon removing the filler nozzle which could cause personal injury.

Leaving the engine running and the fuel cap open can cause the “CHECK ENGINE” lamp to illuminate.

Fuel tank capacity approx. 21.1 US gal (80.0 l). This includes approx. 2.6 US gal (10.0 l) reserve.

Use premium unleaded gasoline:

Posted Octane Index 91 (Average of 96 RON/86 MON).

- **Engine oil**

Engine oil level check, see page 82 or 221.

Fill quantity between upper and lower dipstick marking level: 2.1 US qt (2.0 l).

Recommended engine oils, see page 276.

- **Coolant**

For normal replenishing, use water (potable water quality).

For further information (e.g. anticorrosion/antifreeze), see page 224.

- **Spark plugs**

Approved spark plugs, see page 275.

- **Tire pressure**

For tire pressure, refer to tire pressure label inside the fuel filler flap.

- **Air conditioner**

R-134a refrigerant and special PAG lubricant, see page 276.

- **Bulbs**

High and low beams: Halogen type 9004,
low beam: Xenon, for model SL 600 (SL 500 optional)

high beam (models with Xenon): H 1 (55 W)
fog lamps: H1 (55 W),

turn signal, standing, side marker and parking lamps, front: 2357 NA (28.5/8.3 W/30/2.2 cp), tail, parking, standing and driver's side rear fog lamp: 21/4 W,

turn signal lamps, rear: 21 W/32 cp,
side marker lamps, rear: 10W/6 cp,

stop lamps: 21 W/32 cp,

backup lamps: 21 W/32 cp,

license plate lamps: 5W/4 cp.

Check regularly and before a long trip

202

Check regularly and before a long trip

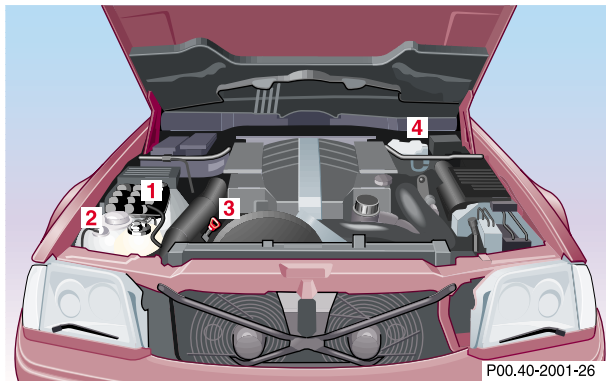

1 Coolant level

See “Adding coolant” on page 223.

2 Windshield washer and headlamp cleaning system

For refilling reservoir see page 225.

3 Engine oil level

See “Checking engine oil level” on page 221 and “Engine oil level indicator” on page 82.

4 Brake fluid

See “Brake fluid” on page 278.

Opening hood, see page 219.

Vehicle lighting: Check function and cleanliness. For replacement of light bulbs, see “Exterior lamps” on page 242.

Exterior lamp switch, see page 84.

Instrument cluster display

Malfunction and indicator lamps in the instrument cluster	204
On-board diagnostic system	
Check engine malfunction indicator lamp	204
Brake warning lamp	204
Brake pad wear indicator lamp	205
Seat belt warning lamp	206
Supplemental restraint system (SRS) indicator lamp	206

Fuel reserve and fuel cap placement warning	207
Electronic stability program (ESP) - warning lamp	207
BAS-/ESP malfunction indicator lamp	207
ABS malfunction indicator lamp	208
Low engine coolant level warning lamp	209
Low windshield and headlamp washer system fluid level warning lamp	210
Low engine oil level warning lamp	210

Charge indicator lamp	211
Exterior lamp failure indicator lamp	211
Roll bar warning lamp	212
ADS indicator lamp	212
High beam indicator lamp	213
Additional function indicator lamps (in the odometer display)	213
Malfunction and indicator lamp (in the dashboard)	213
Passenger airbag indicator lamp	213

Malfunction and indicator lamps

204

Malfunction and indicator lamps in the instrument cluster

General information:

If a bulb in the instrument cluster fails to light up during the bulb self-check when turning the electronic key in steering lock to position 2, have it checked and replaced if necessary.

On-board diagnostic system

Check engine malfunction indicator lamp

 The Sequential Multiport Fuel Injection (SFI) control module monitors emission control components that either provide input signals to or receive output signals from the control module. Malfunctions resulting from interruptions or failure of any of these components are indicated by the “CHECK ENGINE” malfunction indicator lamp in the instrument cluster and are simultaneously stored in the SFI control module.

If the “CHECK ENGINE” malfunction indicator lamp comes on, have the system checked at your authorized Mercedes-Benz Center as soon as possible.

With some exceptions, the control module switches off the “CHECK ENGINE” malfunction indicator lamp if the condition, causing the lamp to come on, no longer exists during three consecutive cycles.

An on-board diagnostic connector is located in the passenger compartment near the engine hood release, allowing the accurate identification of system malfunctions through the readout of diagnostic trouble codes.

Brake warning lamp

 Except Canada

 Canada only

With the key in steering lock position 2, the brake warning lamp will come on. It should go out when the engine is running.

The brake warning lamp will come on:

- when there is insufficient brake fluid in the reservoir (engine running and parking brake released), or
- when the parking brake is set (engine running).

Warning!

Driving with the brake warning lamp illuminated can result in an accident. Have your brake system checked immediately if the brake warning lamp stays on. Don't add brake fluid before checking the brake system. Overfilling the brake fluid reservoir can result in spilling brake fluid on hot engine parts and the brake fluid catching fire. You can be seriously burned.

Note:

If you find that the minimum mark on the brake fluid reservoir is reached, have the brake system checked for brake pad thickness and leaks.

Brake pad wear indicator lamp



With the key in steering lock position 2, the brake pad wear indicator lamp comes on. It goes out when the engine is running.

If the indicator lamp lights up during braking, this indicates that the brake pads are worn down.

Have the brake system checked at your authorized Mercedes-Benz Center as soon as possible.

Malfunction and indicator lamps

206

Seat belt warning lamp

With the key in steering lock position 2, the seat belt warning lamp comes on, and a warning sounds for a short time if the driver's seat belt is not fastened.

If a backrest is not engaged in its lock, a warning will sound intermittently for up to approx. 20 seconds.

After starting the engine, the seat belt warning lamp blinks for a brief period to remind the driver and passengers to fasten seat belts before driving off.

If the warning lamp does not go out after blinking briefly, but is instead lit continuously, then a backrest is not engaged in its lock.

The warning lamp goes out as soon as the backrest is engaged in its lock.

If the backrest is locked and the warning lamp does not go out, have the system checked at your authorized Mercedes-Benz Center as soon as possible.

Supplemental restraint system (SRS) indicator lamp

The operational readiness of the airbag system is verified by the indicator lamp "SRS" in the instrument cluster when turning the key in steering lock to position 1 or 2. If no fault is detected, the lamp will go out after approximately 4 seconds; after the lamp goes out, the system continues to monitor the components and circuitry of the airbag system and will indicate a malfunction by coming on again.

Warning!

In the event a malfunction of the "SRS" is indicated as outlined above, the "SRS" may not be operational. For your safety, we strongly recommend that you visit an authorized Mercedes-Benz Center immediately to have the system checked; otherwise the "SRS" may not be activated when needed in an accident, which could result in serious or fatal injury, or it might deploy unexpectedly and unnecessarily which could also result in injury.

See page 60 for notes on airbags, see page 59 for belt tensioners and page 67 for infant and child seat restraint.

Fuel reserve and fuel cap placement warning



With the key in steering lock position 2, the fuel reserve warning lamp comes on. It should go out immediately when the engine is running.

If the warning lamp does not go out after starting the engine, or if it comes on while driving, it indicates that the fuel level is down to the reserve quantity of approximately 2.6 gal (10 liters).

The warning lamp blinks when the fuel cap is not closed, or a fuel system leak has been detected. Retighten cap and see if warning lamp goes out after restart and next OBD selfcheck.

If the warning lamp continues to blink after closing the fuel cap correctly, have the fuel system checked at your authorized Mercedes-Benz Center as soon as possible.

Leaving the engine running and the fuel cap open can cause the “CHECK ENGINE” lamp to illuminate (see also page 204).

Electronic stability program (ESP) – warning lamp



The yellow ESP warning lamp in the speedometer dial comes on with the key in steering lock position 2. It should go out with engine running.

See page 192 if the warning lamp lights up or flashes when the vehicle is moving.

BAS-/ESP malfunction indicator lamp



The malfunction indicator lamp for the ESP is combined with that of the BAS.

The yellow BAS/ESP malfunction indicator lamp in the instrument cluster come on with the key in steering lock position 2. They should go out with the engine running.

If the BAS/ESP malfunction indicator lamp comes on permanently with the engine running, see page 188 and 192.

Malfunction and indicator lamps

208

ABS malfunction indicator lamp



The ABS malfunction indicator lamp in the instrument cluster comes on with the key in steering lock position 2 and should go out with the engine running.

When the ABS malfunction indicator lamp symbol and warning in the instrument cluster come on while the engine is running, it indicates that the ABS has detected a malfunction and has switched off. In this case, the brake system functions in the usual manner, but without antilock assistance.

With the ABS malfunctioning, the BAS and ESP are also switched off. Both malfunction indicator lamps come on with the engine running.

If the charging voltage falls below 10 volts, the malfunction indicator lamp comes on and the ABS is switched off. When the voltage is above this value again, the malfunction indicator lamp should go out and the ABS is operational.

Have the system checked at your authorized Mercedes-Benz Center as soon as possible.

See page 190 for notes on antilock brake system (ABS).

Low engine coolant level warning lamp



With the key in steering lock position 2, the warning lamp comes on. It should go out when the engine is running.

If the warning lamp does not go out after starting the engine, or if it comes on while driving, then the coolant level has dropped below the required level. If no leaks are noticeable and the engine temperature does not increase, continue to drive to the nearest service station and have coolant added to the coolant system, see page 224.

The low engine coolant level warning light should not be ignored. Extended driving with the light illuminated may cause serious engine damage not covered by the Mercedes-Benz Limited Warranty.

In cases of major or frequent minor coolant loss, have the cooling system checked at your authorized Mercedes-Benz Center as soon as possible.

Note:

Do not drive without coolant in the cooling system. The engine will overheat causing major engine damage.

Monitor the coolant temperature gauge while driving.

Warning!

Do not spill antifreeze on hot engine parts. Antifreeze contains ethylene glycol which may burn if it comes into contact with hot engine parts. You can be seriously burned.

Malfunction and indicator lamps

210

Low windshield and headlamp washer system fluid level warning lamp

With the key in steering lock position 2, the warning lamp comes on. It should go out when the engine is running.

If the warning lamp does not go out after starting the engine, or if it comes on while driving, the level of the reservoir has dropped to approx. 1/3 of the total volume. The reservoir should be refilled with MB Windshield Washer Concentrate "S" and water (or commercially available premixed windshield washer solvent/antifreeze, depending on ambient temperature - see page 88) at the next opportunity. The reservoir for the windshield and headlamp washer systems is located in the engine compartment.

Low engine oil level warning lamp

With the key in steering lock position 2, the oil level warning lamp comes on. It should go out immediately when the engine is running.

If the warning lamp does not go out after starting the engine, or comes on with the engine running and at operating temperature, the engine oil level has dropped to approximately the minimum mark on the dipstick.

When this occurs, the warning lamp will first come on intermittently and then stay on if the oil level drops further.

If no leaks are noted, continue to drive to the nearest service station where the engine oil should be topped to the "full" mark on the dipstick with an approved oil.

The low engine oil level warning light should not be ignored. Extended driving with the light illuminated could result in serious engine damage that is not covered by the Mercedes-Benz Limited Warranty.

In addition to the warning lamp, the engine oil level should be periodically checked with the dipstick, for example during a fuel stop, or before a long trip, see page 221.

Charge indicator lamp



Should the charge indicator lamp fail to come on prior to starting when the key is in steering lock position 2 or should it fail to go out after starting or during operation, this indicates a malfunction which must be repaired immediately at an authorized Mercedes-Benz Center.

If the charge indicator lamp comes on, or a loss of power steering assistance is noticeable while the engine is running, this may indicate that one of the two poly-V-belts has broken. Should this condition occur, the poly-V-belt must be replaced before continuing to operate the vehicle. Otherwise, the engine may overheat due to an inoperative water pump which may result in damage to the engine.

Do not continue to drive the vehicle with the charge indicator lamp illuminated. Doing so could result in serious engine damage that is not covered by the Mercedes-Benz Limited Warranty.

Exterior lamp failure indicator lamp



With the key in steering lock position 2, an indicator lamp comes on. It should go out when the engine is running.

If the warning lamp does not go out after starting the engine, or if it comes on while driving, this lamp indicates a failure in the parking lamp, taillamp, stop lamp, or low beam headlamp.

If an exterior lamp fails, the indicator lamp will come on only when that lamp is switched on.

If a brake lamp fails, the lamp failure indicator will come on when applying the brake and stays on until the engine is turned off.

Note:

If additional lighting equipment is installed (e.g. auxiliary headlamps etc.) be certain to connect into the fuse before the failure indicator monitoring unit in order to avoid damaging the system.

Malfunction and warning messages

212

Roll bar warning lamp

With the key in steering lock position 2, the roll bar warning lamp comes on and goes out with the engine running.

Warning!

If the warning lamp does not go out after starting the engine, or if it comes on while driving, and the indicator lamps in the roll bar switch blink simultaneously, then the roll bar system is not operating properly and may not activate in an accident. In this case, raise the roll bar manually (see page 118) before continuing to drive.

Have the roll bar system checked at your authorized Mercedes-Benz Center as soon as possible.

ADS indicator lamp

If the malfunction indicator stays on after the engine is running, then the oil level in the reservoir is low or the system has detected a malfunction.

Have the ADS checked at your authorized Mercedes-Benz Center as soon as possible.

For detailed information see page 199

High beam indicator lamp



High beam indicator lamp, see page 86

Additional function indicator lamps (in the odometer display)



FSS indicator (distance, Service A),
see page 80.



FSS indicator (distance, Service B),
see page 80.



FSS indicator (days, Service A),
see page 80.



FSS indicator (days, Service B),
see page 80.



Start lock-out malfunction, see page 34.

Malfunction and indicator lamp (in the dashboard)

Passenger airbag indicator lamp



Passenger airbag automatically switched off,
see page 60.

Contents – Practical hints

214

Practical hints

First aid kit	215	Windshield and headlamp washer fluid mixing ratio	225	Exterior lamps	242
Stowing things in the vehicle	215	Wheels	226	Headlamp assembly (Halogen)	243
Vehicle tools	216	Tire replacement	226	Taillamp assemblies	249
Vehicle jack	217	Rotating wheels	227	Changing batteries in the remote control	251
Fuses	218	Spare wheel	228	Synchronizing	252
Hood	219	Changing wheels	230	Raising soft top manually	253
Automatic transmission fluid level	221	Tire inflation pressure	234	Replacing wiper blade insert	257
Checking engine oil level	221	Battery	236	Manual release of fuel filler flap	259
Coolant level	223	Battery Recycling	237	Trunk lamp	259
Adding coolant	224	Jump starting	238		
		Towing the vehicle	240		

First aid kit

The first aid kit is located in the storage compartment behind the seats.

Stowing things in the vehicle

Warning!

To help avoid personal injury during a collision or sudden maneuver, exercise care when stowing things. Put luggage or cargo in the trunk if possible.

Vehicle tools

216

Vehicle tools

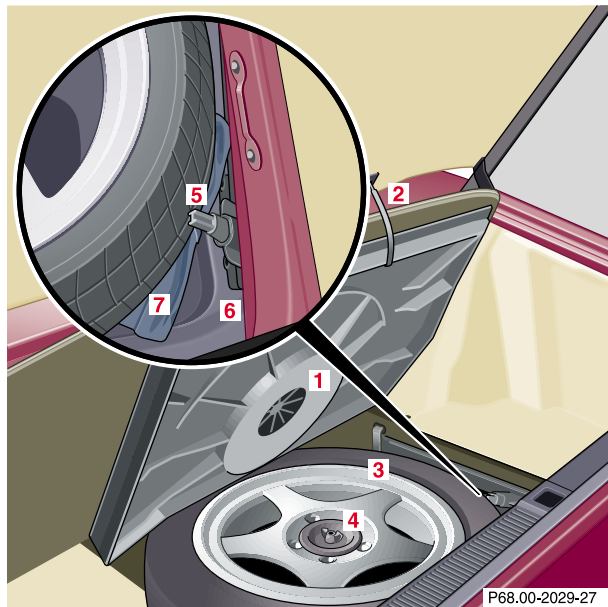

P68.00-2029-27

- 1 Trunk floor
- 2 Strap
- 3 Structured spare wheel
- 4 Wing nut and washer
- 5 Jack arm
- 6 Jack base
- 7 Tool kit

Roll back the floor mat, lift the trunk floor (1) and engage strap (2) in the hooks on the upper edge of the trunk lid.

First remove the vehicle jack, then the spare wheel; reinstall in reverse order.

Vehicle jack

See illustration for proper storage of jack.

Before storing the jack, the jack arm (5) must be lowered almost to the base (6) of the jack.

Note:

First remove the vehicle jack, then the spare wheel; reinstall in reverse order.

Warning!

The jack is designed exclusively for jacking up the vehicle at the jack tubes built into either side of the vehicle. To help avoid personal injury, use the jack only to lift the vehicle during a wheel change.

Never get beneath the vehicle while it is supported by the jack. Keep hands and feet away from the area under the lifted vehicle. Always firmly set parking brake and block wheels before raising vehicle with jack.

Do not disengage parking brake while the vehicle is raised. Be certain that the jack is always vertical when in use, especially on hills. Always try to use the jack on level surface. Be sure that the jack arm is fully inserted in the jack tube. Always lower the vehicle onto sufficient capacity jackstands before working under the vehicle.

Fuses

218

Fuses



1 Main fuse box in engine compartment

2 Auxiliary fuse box in trunk on rear wall

Before replacing a blown fuse, determine the cause of the short circuit.

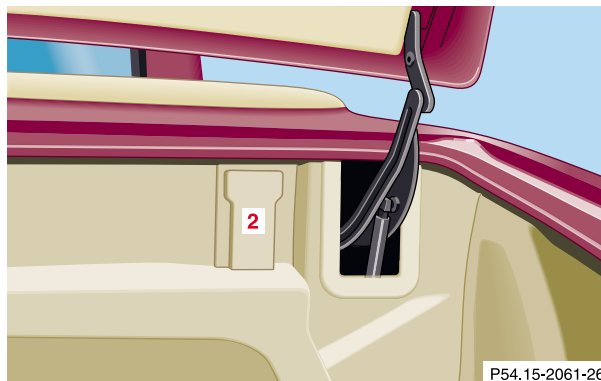

Spare fuses are supplied inside the fuse box. Observe amperage and color of fuse.

Always use a new fuse for replacement. Never attempt to repair or bridge a blown fuse.

A fuse chart can be found inside the corresponding fuse box cover.

After replacing a blown fuse, close fuse box cover.

Hood

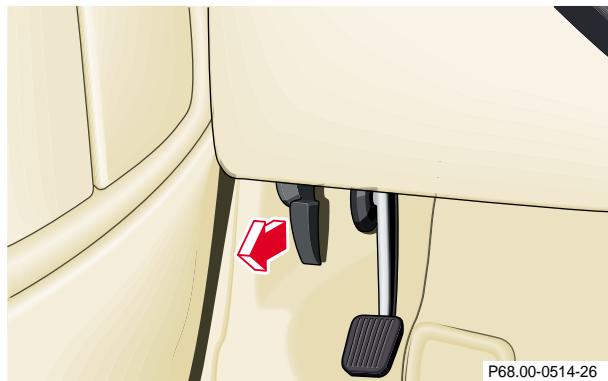

To open:

To unlock the hood, pull release lever under the driver's side of the instrument panel.

Pull handle (2) up and open hood.

Caution!

To avoid damage to the windshield wipers or hood, open the hood only with wipers in the parked position.

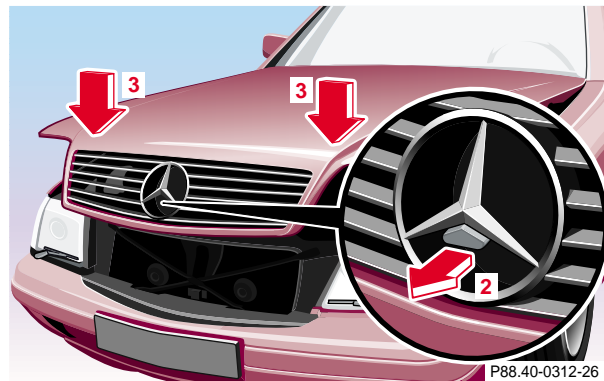

Pull handle (2) to its stop out of radiator grill, and open hood (do not pull up on handle).

Note:

Do not lift hood at louvers of grill! Make certain the windshield wiper arm is not folded forward.

Engine compartment

220

To close:

Lower hood and let it drop into lock from a height of approx. 1 ft. (30 cm), assisting with hands placed flat on edges of hood (3).

To avoid hood damage, please make sure that hood is fully closed. If not, repeat closing procedure. Do not push down on hood to attempt to fully close it.

Warning!

To help prevent personal injury, stay clear of moving parts when the hood is open and the engine is running. Be sure the hood is properly closed before driving. When closing hood, use extreme caution not to catch hands or fingers.

The radiator fan may continue to run another approximate 30 seconds or even restart after the engine has been turned off. Stay clear from fan blades.

The engine is equipped with a transistorized ignition system. Because of the high voltage it is dangerous to touch any components (ignition coils, spark plug sockets, diagnostic socket) of the ignition system

- **with the engine running,**
- **while starting the engine,**
- **if ignition is “on” and the engine is turned manually.**

If you see flames, steam or smoke coming from the engine compartment, or if the coolant temperature gauge indicates that the engine is overheated, do not open the hood. Move away from vehicle and do not open the hood until the engine has cooled. If necessary, call a fire department.

Automatic transmission fluid level

The transmission has a permanent fill of automatic transmission fluid.

Regular automatic transmission fluid level checks and changes are not required. For this reason the dipstick is omitted.

If you notice fluid loss or gear shifting malfunctions, have your authorized Mercedes-Benz Center check the transmission fluid level.

Checking engine oil level

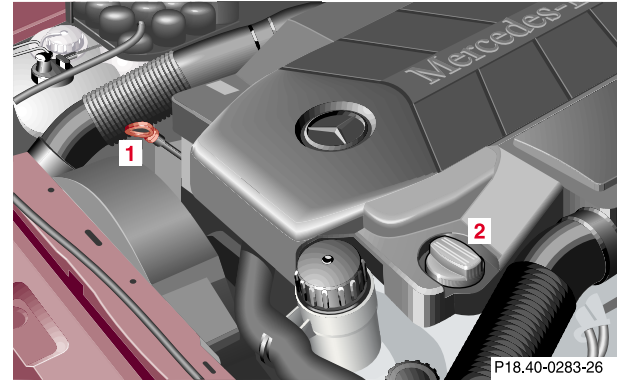

SL 500

- 1 Oil dipstick
- 2 Oil filler cap

To check the engine oil level, park vehicle on level ground, with engine at normal operational temperature.

Check engine oil level approximately 5 minutes after stopping the engine, allowing for the oil to return to the oil pan.

Checking engine oil level

222

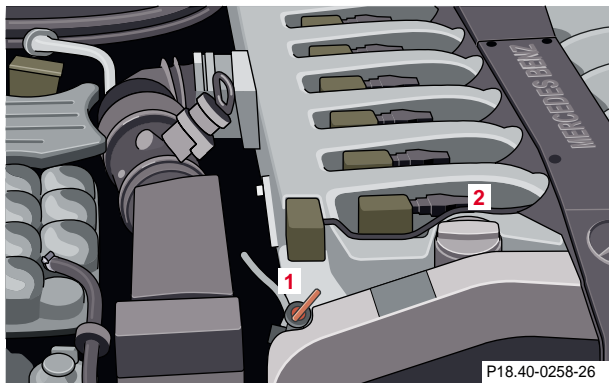

P18.40-0258-26

SL 600

- 1 Oil dipstick
- 2 Oil filler cap

Wipe oil dipstick clean prior to checking the engine oil level. Fully insert dipstick in tube, and remove after three seconds to obtain accurate reading.



Oil level must be between the lower (min) and upper (max) mark of the dipstick.

Fill quantity between upper and lower dipstick marking level is approximately 2.1 US qt (2.0l).

Do not overfill the engine.

Excessive oil must be drained or siphoned. It could cause engine damage not covered by the Mercedes-Benz Limited Warranty.

For low engine oil level warning, see page 210.

Coolant level

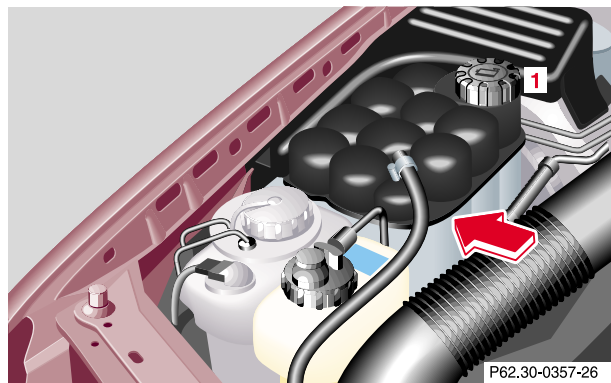

1 Cap for coolant reservoir

The coolant level can be checked visually at the transparent coolant reservoir.

To check the coolant level, the vehicle must be parked on level ground.

Check coolant level only when coolant is cold:

The coolant should reach the rib in the filler neck. Also see marking (arrow) on reservoir.

Adding coolant

If coolant has to be added, a 50/50 mixture of water and MB anticorrosion/antifreeze should be added.

Model SL 500

The drain plugs for the cooling system are located on the right side of the engine block and at the bottom of the radiator.

Model SL 600

The drain plugs for the cooling system are located on the right and left sides of the engine block and at the bottom of the radiator.

Anticorrosion/antifreeze, see coolants on page 280.

Warning!

In order to avoid possible serious burns or injury:

- Use extreme caution when opening the hood if there are any signs of steam or coolant leaking from the cooling system, or if the coolant temperature gauge indicates that the engine is overheated.
- Do not remove pressure cap on coolant reservoir if engine temperature is above 194°F (90°C). Allow engine to cool down before removing cap. The coolant reservoir contains hot fluid and is under pressure.
- Using a rag, slowly open cap approximately 1/2 turn to relieve excess pressure. If opened immediately, scalding hot fluid and steam will be blown out under pressure.
- Do not spill antifreeze on hot engine parts. Antifreeze contains ethylene glycol which may burn if it comes into contact with hot engine parts.

Windshield and headlamp washer fluid mixing ratio



1 Windshield washer/headlamp cleaning system fluid reservoir

Vehicles without ADS:

Capacity approx. 5.3 US qt (5.0 l)

Vehicles with ADS:

Capacity approx. 3.2 US qt (3.0 l)

The reservoir should be refilled with MB Windshield Washer Concentrate and water (or concentrate commercially available premixed windshield washer solvent/antifreeze, depending on ambient temperatures).

For temperatures above freezing:

MB Windshield Washer Concentrate “S” and water.

1 part “S” to 100 parts water
(40 ml “S” to 1 gallon water)

For temperature below freezing:

MB Windshield Washer Concentrate “S” and commercially available premixed windshield washer solvent/antifreeze.

1 part “S” to 100 parts solvent
(40 ml “S” to 1 gallon solvent).

Tires, Wheels

226

Wheels

Replace rims or tires with the same designation, manufacturer and type as shown on the original part. See your authorized Mercedes-Benz Center for further information.

See your authorized Mercedes-Benz Center for information on tested and recommended rims and tires for summer and winter operation. They can also offer advice concerning tire service and purchase.

Tire replacement

Front and rear tires should be replaced in sets. Furthermore - in the event of tire replacement - the spare wheel (except Sport Package version), if possible, should be used on the rear axle. Rims and tires must be of the correct size and type. For dimensions, see page 273.

We recommend that you break in new tires for approx. 60 miles (100 km) at moderate speed.

It is imperative that the wheel mounting bolts be fastened to a tightening torque of 80 ft.lb. (110 Nm) whenever wheels are mounted.

For rim and tire specifications, see page 273.

Warning!

When replacing a tire on the 9 1/2 J x 18 H2 (Sport Package SL 500) or 10 J x 18 H2 (Sport Package SL 600) wheel rim, removal or mounting must only be done over the back flange. Removal or installation over the front flange will cause rim/tire failure leading to serious or fatal injury.

Worn, old tires can cause accidents. If the tire tread is badly worn, or if the tires have sustained damage, replace them.

When replacing rims, use only genuine Mercedes-Benz wheel bolts specified for the particular rim type. Failure to do so can result in the bolts loosening and possibly an accident.

Rotating wheels

Wheel rotation applies only when winter tires are mounted on all four wheels.

The wheels can be rotated according to the degree of tire wear while retaining the same direction of travel.

Rotating, however, should be carried out as recommended by the tire manufacturer, before the characteristic tire wear pattern (shoulder wear on front wheels and tread center wear on rear wheels) becomes visible, as otherwise the driving properties deteriorate.

Important!

Unidirectional tires must always be mounted with arrow on tire sidewall pointing in direction of vehicle forward movement.

Notes:

Tires, Wheels

228

Thoroughly clean the inner side of the wheels any time you rotate the wheels or wash the vehicle underside.

The use of retread tires is not recommended. Retread tires may adversely affect the handling characteristics and safety of the vehicle.

Dented or bent rims can cause tire pressure loss and damage to the tire beads. For this reason, check rims for damage at regular intervals. The rim flanges must be checked for wear before a tire is mounted. Remove burrs, if any.

Check and ensure proper tire inflation pressure after rotating the wheels. For tire inflation pressure see page 234.

Spare wheel
(except Sport Package)

The spare wheel rim size is 8 1/4 J x 17 H2.

In the case of a flat tire, or breakdown, you may temporarily use the spare wheel.

Unidirectional tires must always be mounted with arrow on tire sidewall pointing in direction of vehicle forward movement.

If the arrow on tire sidewall does not point in direction of vehicle forward movement when using the spare wheel, observe the following restrictions:

- Drive to the nearest repair facility to have the flat tire repaired or replaced as appropriate.
- Do not operate vehicle with more than one spare wheel mounted.

For additional information, refer to page 273.

Warning!

The spare wheel rim is for temporary use only. Use for over a total of 12 000 miles (20 000 km) (aggregate of all uses) may cause wheel rim failure leading to an accident and possible injuries.

Spare Wheel (with Sport Package)

The spare wheel rim size is 8 1/4 J x 17 H2 with tire size 245/45 R 17 95W.

In the case of a flat tire or breakdown, you may temporarily use the spare wheel.

Unidirectional tires must always be mounted with arrow on tire sidewall pointing in direction of vehicle forward movement. If the arrow on tire sidewall does not point in direction of vehicle forward movement when using the spare wheel, observe the following restrictions:

- Do not exceed vehicle speed of 50 mph (80 km/h).
- Drive to the nearest repair facility to have the flat tire repaired or replaced as appropriate.
- Do not operate vehicle with more than one spare wheel mounted.

For additional information, refer to page 273.

Warning!

The spare wheel rim is for temporary use only. Use for over a total of 12 000 miles (20 000 km) may cause wheel rim failure leading to an accident and possible injuries.

The dimensions of the spare wheel are different from those of road wheels. As a result, the vehicle handling characteristics change when driving with a mounted spare wheel.

The spare wheel should only be used temporarily, and replaced with a regular road wheel as quickly as possible.

Changing wheels

The jack is designed exclusively for jacking up the vehicle at the jack tubes built into either side of the vehicle. To help avoid personal injury, use the jack only to lift the vehicle during a wheel change.

Never get beneath the vehicle while it is supported by the jack. Keep hands and feet away from the area under the lifted vehicle. Always firmly set parking brake and block wheels before raising vehicle with jack.

Do not disengage parking brake while the vehicle is raised. Be certain that the jack is always vertical when in use, especially on hills. Always try to use the jack on level surface. Be sure that the jack arm is fully inserted in the jack tube. Always lower the vehicle onto sufficient capacity jackstands before working under the vehicle.

Before working on the vehicle, e.g. when changing wheels, the roll bar should be raised with the switch, and the key be removed from the steering lock, to prevent possible injury.

Move vehicle to a level area which is a safe distance from the roadway.

1. Firmly set parking brake, raise roll bar, and turn on hazard warning flasher.
2. Move selector lever to position "P".
3. While engine is running, depress wheel change switch for level control. The indicator lamp in the switch and the ADS malfunction indicator lamp light up.
4. Turn off engine.
5. Prevent vehicle from rolling away by blocking wheels with wheel chocks (not supplied with vehicle) or sizable wood block or stone. When changing a wheel on a hill, place chocks on the downhill side blocking both wheels of the other axle. On a level road, place one chock in front of and one behind the wheel that is diagonally opposite to the wheel being changed.

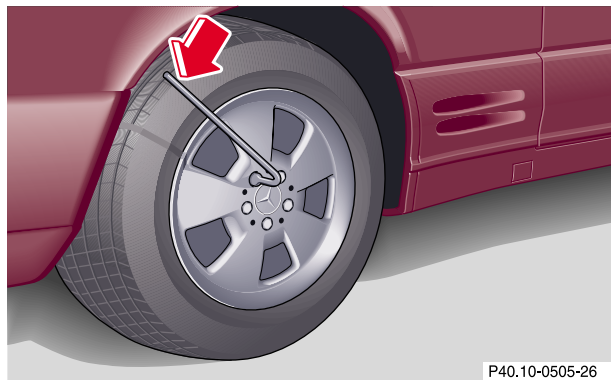

6. Using the wrench, loosen but do not yet remove the wheel bolts.

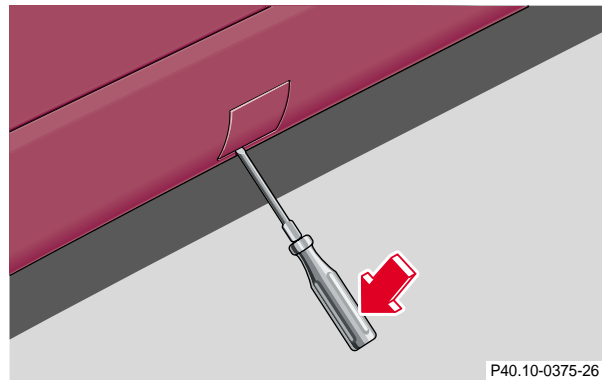

7. Remove the protective cover from the jack support tube opening by inserting the screwdriver in the opening and prying it out.

The tube openings are located directly behind the front wheel housings and in front of the rear wheel housings.

Tires, Wheels

232

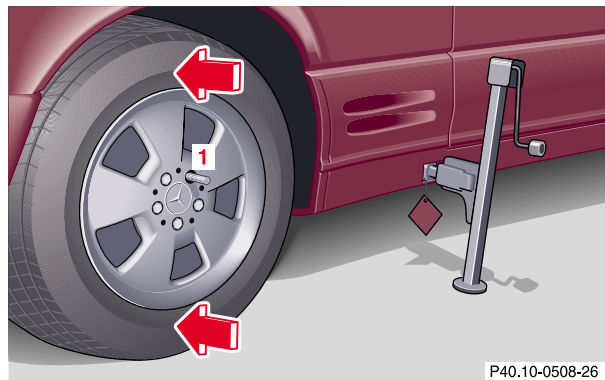
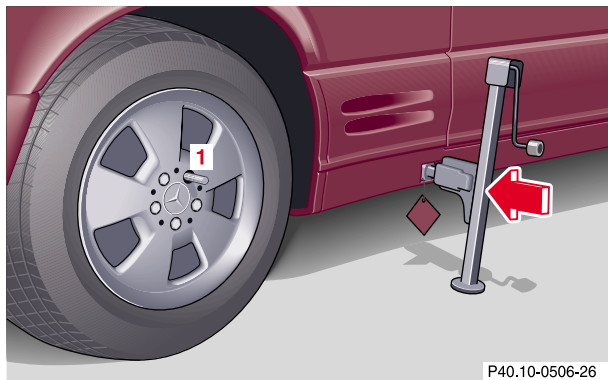

8. Insert jack arm fully into the tube hole up to the stop. Place jack on firm ground. Position the jack so that it is always vertical (plumb-line) as seen from the side (see arrow), especially if the vehicle is parked on an incline.
9. Jack up the vehicle until the wheel is clear of the ground. Never start engine while vehicle is raised.
10. Unscrew upper-most wheel bolt and install alignment bolt (1) supplied in the tool kit. Remove the remaining bolts. Keep bolt threads protected from dirt and sand.

11. Remove wheel. Grip wheel from the sides. Keep hands from beneath the wheels.
12. Clean contact surfaces of wheel and wheel hub. Install spare wheel on wheel hub. Insert wheel bolts and tighten them slightly.

To avoid paint damage, place wheel flat against hub and hold it there while installing first wheel bolt.

Unscrew the alignment bolt (1) to install the last wheel bolt.

13. Lower vehicle. Remove jack and insert jack tube cover.

Before storing the jack, the jack arm must be lowered almost to the base of the jack.

Store the spare wheel first and then the vehicle jack.

Warning!

Always replace wheel bolts that are damaged or rusted.

Never apply oil or grease to wheel bolts.

Damaged wheel hub threads should be repaired immediately.

Incorrect mounting bolts or improperly tightened mounting bolts can cause the wheel to come off. This could cause an accident. Be sure to use the correct mounting bolts.

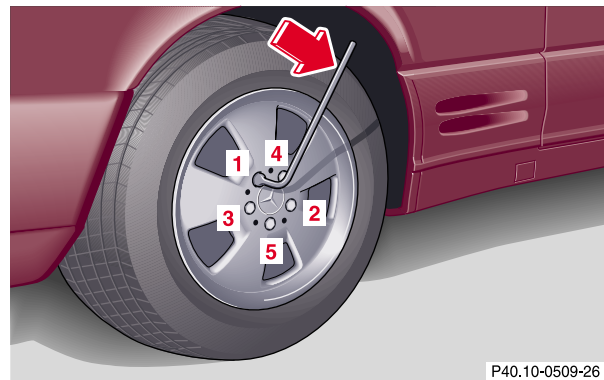

14. Using the wrench, tighten the five bolts evenly, following the sequence illustrated, until all bolts are tight.

Observe a tightening torque of 80 ft.lb. (110 Nm).

15. Ensure proper tire pressure.

16. Depress wheel change switch for level control. The indicator lamp in the switch and the ADS malfunction indicator lamp will go out.

Warning!

Do not drive the vehicle while the wheel change switch is activated since the vehicle suspension will not function properly.

Warning!

The spare wheel rim is for temporary use only. Use for over a total of 12 000 miles (20 000 km) may cause wheel rim failure leading to an accident and possible injuries.

Vehicles with Sport Package:

The dimensions of the spare wheel are different from those of road wheels. As a result, the vehicle handling characteristics change when driving with a mounted spare wheel.

The spare wheel should only be used temporarily, and replaced with a regular road wheel as quickly as possible.

Tire inflation pressure

A table (see fuel filler flap) lists the tire inflation pressures specified for Mercedes-Benz recommended tires as well as for the varying operating conditions.

Important!

Tire pressure changes by approx. 1.5 psi (0.1 bar) per 18°F (10°C) of air temperature change. Keep this in mind when checking tire pressure inside a garage - especially in the winter.

Example:

If garage temperature = approx. +68°F (+20°C) and ambient temperature = approx. +32°F (0°C) then the adjusted air pressure = specified air pressure +3psi (+0.2 bar).

Tire pressures listed for light loads are minimum values offering high driving comfort. Increased inflation pressures for heavy loads produce favorable handling characteristics with lighter loads and are perfectly permissible. The ride of the vehicle, however, will become somewhat harder.

Tire temperature and pressure increase with the vehicle speed. Tire pressure should therefore only be checked and corrected on cold tires. Correct tire pressure in

warm tires only if pressure has dropped below the pressure listed in the table and the respective operating conditions are taken into consideration.

An underinflated tire due to a slow leak (e.g. due to a nail in the tire) may cause damage such as tread separation, bulging etc. Regular tire pressure checks at intervals of no more than 14 days are therefore essential.

If a tire constantly loses air, it should be inspected for damage.

The spare tire should be checked periodically for condition and inflation. Spare tire will age and become worn over time even if never used, and thus should be inspected and replaced when necessary.

Warning!

Do not overinflate tires. Overinflating tires can result in sudden deflation (blowout) because they are more likely to become punctured or damaged by road debris, potholes etc. Follow recommended inflation pressures.

Do not overload the tires by exceeding the specified vehicle capacity weight (as indicated by the label on the driver's door latch post). Overloading the tires can overheat them, possibly causing a blowout.

Battery**Warning!**

Failure to follow these instructions can result in severe injury or death.

Never lean over batteries while connecting, you might get injured.

Battery fluid contains sulfuric acid. Do not allow this fluid to come in contact with eyes, skin or clothing. In case it does, immediately flush affected area with water and seek medical help.

A battery will also produce hydrogen gas, which is flammable and explosive. Keep flames or sparks away from battery, avoid improper connection of jumper cables, smoking etc.

Important!

Battery replacement information:

The maintenance-free battery is located in the trunk behind the right side cover panel.

The service life of the battery is dependent on its condition of charge. The battery should always be kept sufficiently charged, in order to last an optimum length of time.

Therefore, we strongly recommend that you have the battery charge checked frequently, and corrected if necessary, especially if you use the vehicle less than approximately 200 miles (300 km) per month, mostly for short distance trips, or if it is not used for long periods of time.

Only charge a battery with a battery charger after the battery has been disconnected from the vehicle's electrical circuit.

Always disconnect the battery negative lead first and connect last.

When removing and connecting the battery, always make sure that all electrical consumers are off and the key is in steering lock position 0. The battery must always be securely installed when the vehicle is in operation. During removal and installation always protect the disconnected battery positive (+) terminal with the cover attached to the battery.

While the engine is running the battery terminal clamps must not be loosened or detached, otherwise the generator and other electronic components will be damaged.

Important!

Do not close a door with the windows fully closed while the power supply is interrupted (battery disconnected or empty).

Doing so could damage the window frame.

Note:

After reconnecting the battery also set the clock, resynchronize the express feature of the power windows, the electronic stability program (ESP) and the adaptive damping System (ADS).

See page 79 for setting clock, page 41 for power windows, page 193 for ESP and page 199 for ADS.

Battery Recycling

Batteries contain materials that can harm the environment with improper disposal.

Large 12 Volt storage batteries contain lead.

Recycling of batteries is the preferred method of disposal.

Many states require sellers of batteries to accept old batteries for recycling.

Jump starting

238

Jump starting**Warning!**

Failure to follow these directions will cause damage to the electronic components, and can lead to a battery explosion and severe injury or death.

Never lean over batteries while connecting or jump starting, you might get injured.

Battery fluid contains sulfuric acid. Do not allow this fluid to come in contact with eyes, skin or clothing. In case it does, immediately flush affected area with water, and seek medical help if necessary.

A battery will also produce hydrogen gas, which is flammable and very explosive. Keep flames or sparks away from battery, avoid improper connection of jumper cables, smoking etc.

Read all instructions before proceeding.

Important!

A discharged battery can freeze at approx. +14°F (-10°C). In that case, it must be thawed out before jumper cables are used. Attempting to jump start a frozen battery can result in it exploding, causing personal injury.

Jumper cable specifications:

- Minimum cable cross-section of 25 mm² or approx. 2 AWG
- Maximum length of 11.5 ft. (3.5 m).

If the battery is discharged, the engine should be started with jumper cables and the (12 V) battery of another vehicle.

Only use 12 V battery to jump start your vehicle. Jump starting with more powerful battery could damage the vehicle's electrical systems, which will not be covered by the Mercedes-Benz Limited Warranty.

The battery is located in the trunk behind the right side cover panel.

Proceed as follows:

1. Position the vehicle with the charged battery so that the jumper cables will reach, but never let the vehicles touch. Make sure the jumper cables do not have loose or missing insulation.
2. On both vehicles:
 - Turn off engine and all lights and accessories, except hazard warning flashers or work lights.
 - Apply parking brake and shift selector lever to position "P".

Important!

3. Clamp one end of the first jumper cable to the positive (+) terminal of the discharged battery and the other end to the positive (+) terminal of the charged battery. Make sure the cable clamps do not touch any other metal parts.
4. Clamp one end of the second jumper cable to the grounded negative (-) terminal of the charged battery and the final connection to the negative (-) terminal of the discharged battery.

Important!

5. Start engine of the vehicle with the charged battery and run at high idle. Make sure the cables are not on or near pulleys, fans, or other parts that will move when the engine is started. Allow the discharged battery to charge for a few minutes. Start engine of the disabled vehicle in the usual manner.
6. After the engine has started, remove jumper cables by exactly reversing the above installation sequence, starting with the last connection made first. When removing each clamp, make sure that it does not touch any other metal while the other end is still attached.

Note:

If engine does not run after several unsuccessful starting attempts, have it checked at the nearest authorized Mercedes-Benz Center.

Excessive unburned fuel may damage the catalytic converter.

Towing the vehicle

240

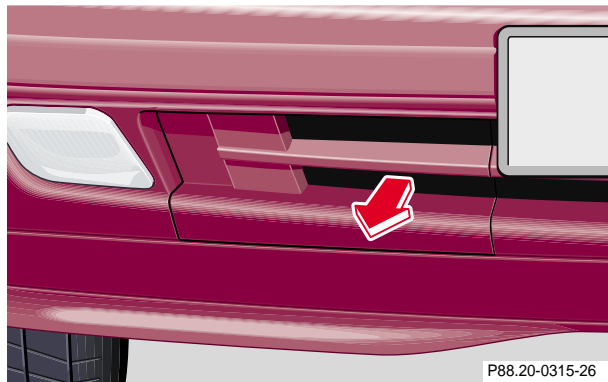
Towing the vehicle**All except Sport Package**

The rear towing eye is located at the right, below the bumper. The front towing eye is located on the passenger side behind a flap in the bumper panel.

Cover removal for all except Sport Package version: Insert finger in recess of flap and pull flap out.

Cover removal for Sport Package version: Pull cover away from bumper.

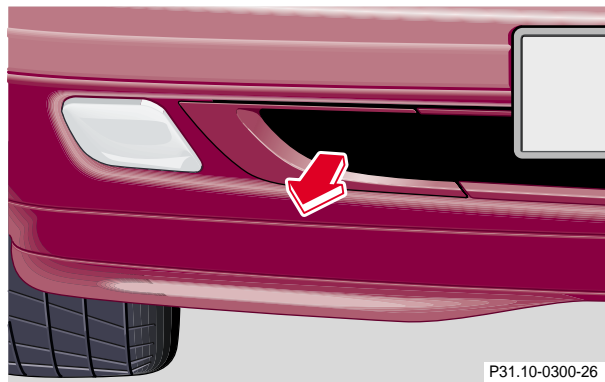
**Sport Package**

Cover installation for all except Sport Package version: Engage cover at bottom and press in top securely.

Cover installation for Sport Package version: Engage right cover end, and press in left cover end securely.

We recommend that the vehicle be transported using flat bed equipment. This method is preferable to other types of towing.

The vehicle may be towed with all wheels on the ground and the selector lever in position “N” for distances up to 30 miles (50 km) and at a speed not to exceed 30 mph (50 km/h). The key must be in steering lock position 2.

To be certain to avoid a possibility of damage to the transmission, however, we recommend the drive shaft be disconnected at the rear axle drive flange for any towing beyond a short tow to a nearby garage.

Do not tow with sling-type equipment. Towing with sling-type equipment over bumpy roads will damage radiator and supports.

The use of wheel lift equipment will damage engine oil pan.

Important!

When towing the vehicle, please, note the following:

With the automatic central locking activated and the key in steering lock position 2, the vehicle doors lock if the left front wheel as well as the right rear wheel are turning at vehicle speeds of approx. 9 mph (15 km/h) or more.

To prevent the vehicle door locks from locking, deactivate the automatic central locking.

When transporting vehicle on flat bed equipment, the front end of the vehicle must be loaded first. Additional ramping may be required for loading to protect bumper fascia.

Warning!

With the engine not running, there is no power assistance for the braking and steering systems. In this case, it is important to keep in mind that a considerably higher degree of effort is necessary to brake and steer the vehicle.

Note:

To signal turns while being towed with hazard warning flasher in use, turn key in steering lock to position 2 and activate combination switch for left or right turn signal in usual manner – only the selected turn signal will operate.

Upon canceling the turn signal, the hazard warning flasher will operate again.

Exterior lamps

Replacing bulbs

To prevent a possible electrical short circuit, switch off lamp prior to replacing a bulb.

When replacing bulbs, install only 12 volt bulbs with the specified watt rating.

When replacing halogen bulbs do not touch glass portion of bulb with bare hands. Use plain paper or a clean cloth.

Warning!

Bulbs and bulb holders can be very hot. Allow the lamp to cool down before changing a bulb.

Halogen lamps contain pressurized gas. A bulb can explode if you:

- touch or move it when hot,
- drop the bulb,
- scratch the bulb.

Wear eye and hand protection.

Warning!

Because of high voltage in Xenon lamps, it is dangerous to replace the bulb or repair the lamp and its components. We recommend that you have such work done by a qualified technician.

Headlamp assembly (Halogen)

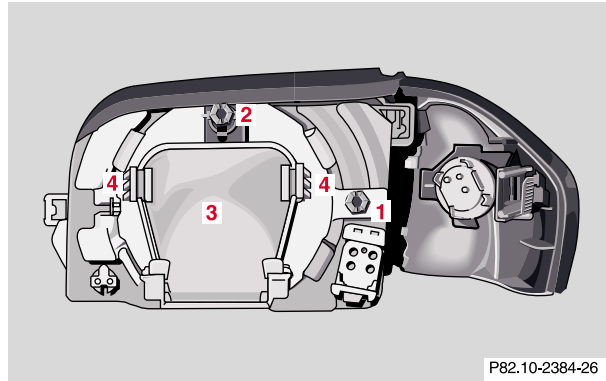

- 1 Headlamp horizontal adjustment screw
- 2 Headlamp vertical adjustment screw
- 3 High and low beam headlamp cover
- 4 Squeeze latches for high and low beam headlamp cover

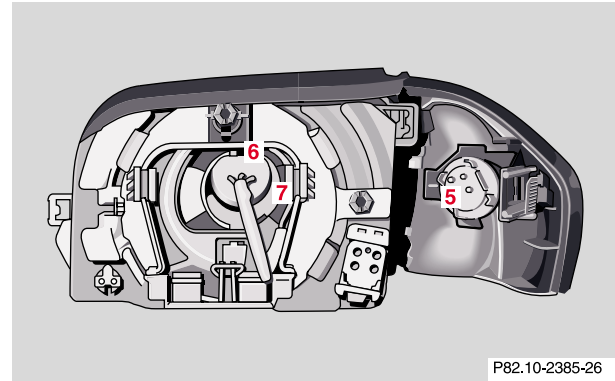

- 5 Turn signal, parking, side marker and standing lamp bulb
- 6 Electrical connector for high and low beam headlamp bulb
- 7 Clamping ring for high and low beam headlamp bulb

Exterior lamps

244

Bulb for high and low beam (Halogen type 9004)

Squeeze latches (4) and remove cover (3) upwards. Pull off electrical connector (6). Turn clamping ring (7) counterclockwise and pull out bulb together with clamping ring. Remove bulb.

Insert new bulb (flat side facing up), mount clamping ring (7) (with tab facing down) and turn clockwise. Push electrical connector on securely.

Turn signal, parking, side marker and standing lamp (2357 NA (28.5/8.3 W/30/2.2 cp) (bulb)

Open hood.

Turn bulb socket (5) with bulb counterclockwise and pull out. Push bulb into socket, turn counterclockwise and remove.

Insert new bulb in socket, push in and twist clockwise. Reinstall bulb socket, push in and twist clockwise.

Headlamp assembly (Xenon)

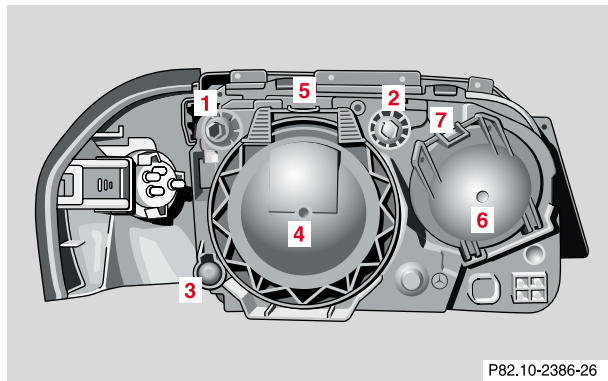

- 1 Headlamp horizontal adjustment screw
- 2 Headlamp vertical adjustment screw
- 3 Adjuster for horizontal adjustment scale
- 4 Cover for low beam headlamp
- 5 Latch for cover (4)
- 6 Cover for high beam headlamp
- 7 Latch for cover (6)

Warning!

Because of high voltage in Xenon lamps, it is dangerous to replace the bulb or repair the lamp and its components. We recommend that you have such work done by a qualified technician.

Exterior lamps

246

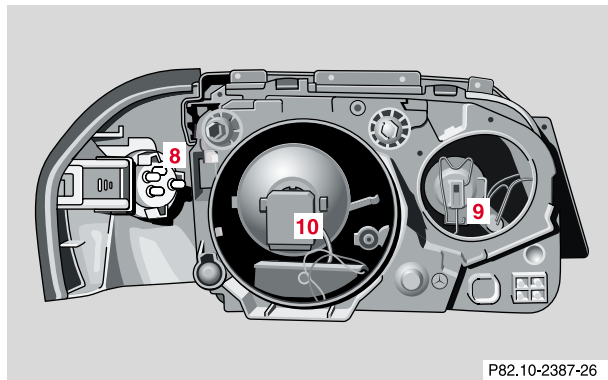

P82.10-2387-26

- 8** Turn signal, parking, side marker and standing lamp bulb
- 9** Electrical connector for high beam headlamp bulb
- 10** Electrical connector for low beam headlamp bulb

Adjusting headlamp aim

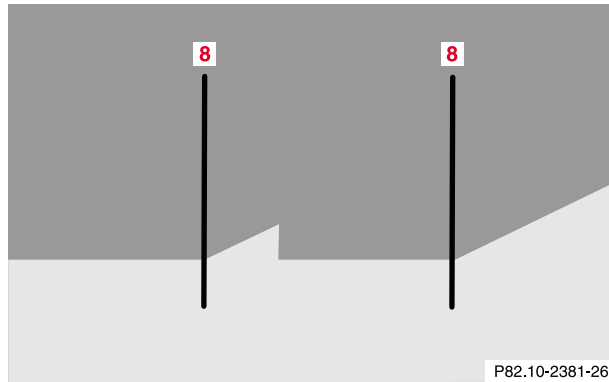

Correct headlamp adjustment is extremely important. To check and readjust a headlamp, follow steps 1 through 7. Please note:

- Adjustments to low beam simultaneously aim the high beam.
- Vehicle should have a normal trunk load.
- Vertical aim adjustments change horizontal aim.

1. Park vehicle on level surface approximately 25 ft. (7.6 m) from a vertical test screen or wall. The centerline of the vehicle must be at a 90° angle to the test screen.
2. (Low beams on):
Using a carpenter's level, align and mark a vertical centerline (8) on the test screen using the vertex of the angle formed in each beam image. As a check, the distance between centerlines should be $49 \frac{5}{8}$ inches (1260 mm). If the distance does not check, have the system verified by an authorized Mercedes-Benz Center.
3. Open hood.
4. Vertical headlamp aim (Low beams on):
Turn adjusting screw (2) (counterclockwise to adjust headlamp downward, clockwise upward) until bubble in the level (6) is centered on the "0" mark. Graduations: 0.18° pitch.

Exterior lamps

248

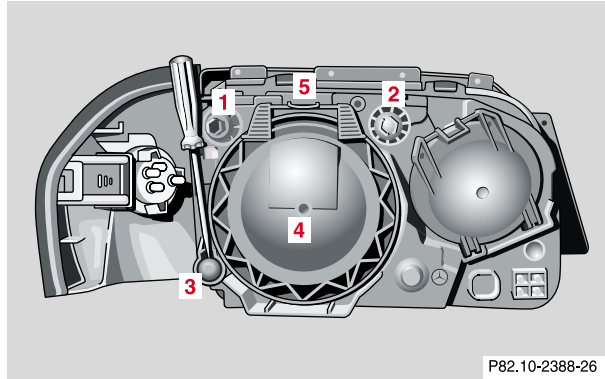

5. Horizontal headlamp aim (Low beams on):
Turn adjusting screw (1) (Right front headlamp: counterclockwise to adjust to the left, clockwise to the right; left front headlamp: counterclockwise to adjust to the right, clockwise to the left.) until the headlamps (low beam) illuminate the test screen as shown. The vertex of the angle formed in each beam image should align with the vertical centerline (8) of each lamp. The left and right headlamps must be adjusted individually.

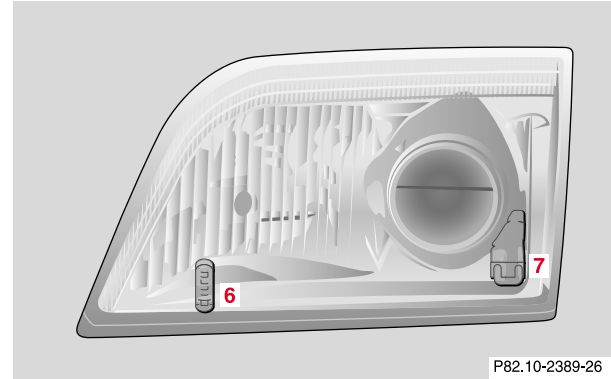

6. This indicator (7) in the sight glass should align with the “0” mark after any horizontal adjustment. If it does not, depress latch (5) and remove access cover (4) from the headlamp (left side only). Insert and turn screwdriver on adjuster (3) until scale (7) is centered on the “0” mark.
Graduations: 0.38° pitch.
7. Reinstall access cover (4).

Note:

If it is not possible to obtain a proper headlamp adjustment, have the system checked at your authorized Mercedes-Benz Center.

Taillamp assemblies

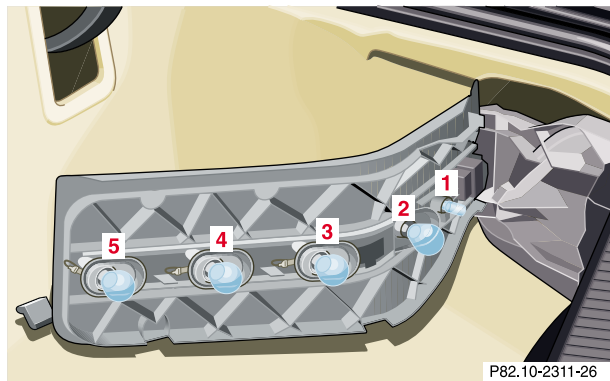

- 1 Side marker lamp
(10 W/6 cp bulb)
- 2 Turn signal lamp
(21 W/32 cp bulb)
- 3 Tail, parking and standing lamp
(21/4 W/32/2 cp bulb)
Driver's side:
Tail, parking, standing and rear fog lamp
(21/4 W/32/2cp bulb)
- 4 Backup lamp
(21 W/32 cp bulb)
- 5 Stop lamp
(21 W/32 cp bulb)

Exterior lamps

250

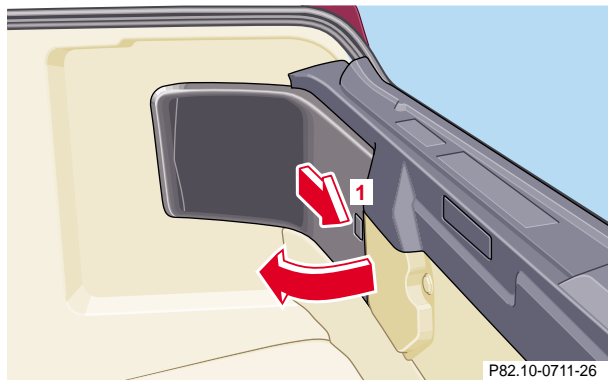

To replace bulbs:

Push the locking button (1) on the rear of the lamp support inward and swing open lamp support. Push down the bulb to be changed, turn counterclockwise and remove.

Insert new bulb in socket, push in and twist clockwise. Close lamp support.



**License plate lamps (5 W/4cp bulb)**

Loosen both securing screws (1), remove lamp and take out bulb.

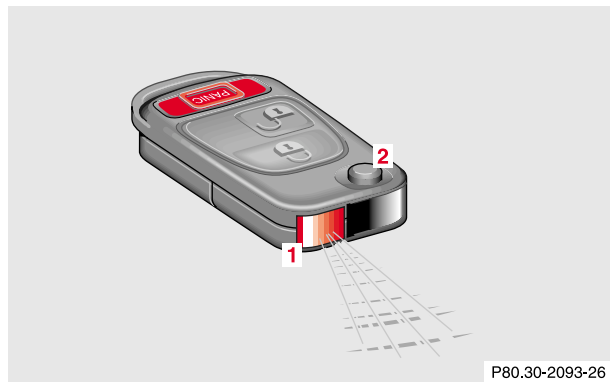
Changing batteries in the remote control



Checking batteries

If the transmit button  or  is pressed longer than 1 second, the battery check lamp in the transmitter eye (1) lights up briefly – indicating that the batteries are in order.

Change batteries if the battery check lamp does not light up briefly.

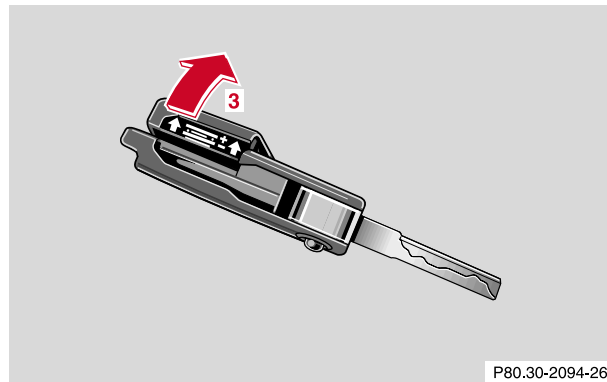

Changing batteries

Unfold master key from holder by pressing key release button (2). Pull off battery cover (3).

Remote control

252

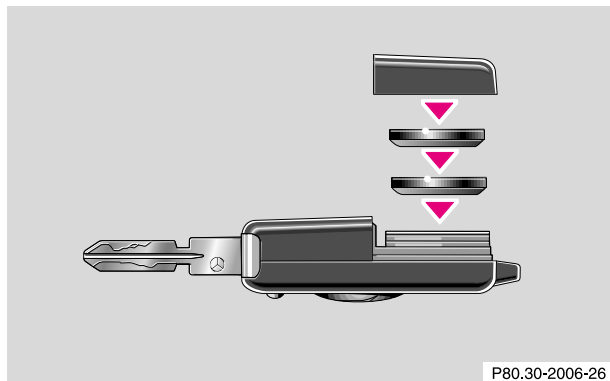

Change batteries, inserting new ones with plus (+) side facing up.

Press battery cover onto housing until locked in place.



Important!

Batteries contain materials that can harm the environment if disposed of improperly. Recycling of batteries is the preferred method of disposal. For disposal, please follow manufacturer's recommendation on battery package.

Replacement Battery:
Lithium, type CR 2025 or equivalent.

Synchronizing remote control

The system may have to be resynchronized, if the transmitter is without voltage for several minutes.

To synchronize system, aim transmitter eye at vehicle and briefly press transmit button  or  twice. Within approx. 30 seconds insert key in steering lock and turn it to position 2.

The remote control should once again be operational.

Raising soft top manually

In case of malfunction, the power soft top can also be raised manually. This procedure should be performed with great care by 2 persons.

A combination open-end/Allenhead wrench in the vehicle tool kit is required for this job.

1. Open doors or lower windows.
2. Lower roll bar with roll bar switch. If the roll bar cannot be lowered, the soft top can be carefully guided over the roll bar.
3. For safety reasons, remove key from steering lock.

Warning!

Do not place your hands near the roll bar, soft top frame, upper windshield area or soft top storage compartment while the soft top is being locked. Serious personal injury may occur.

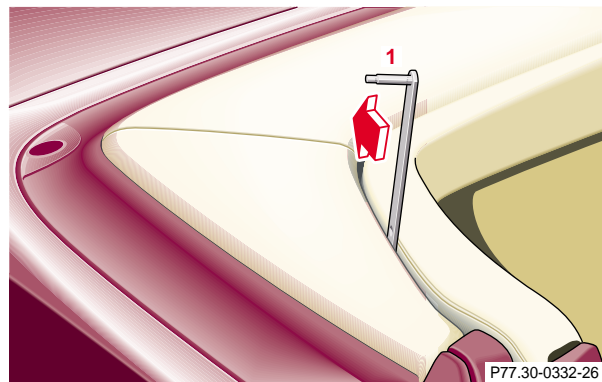

4. Unlock soft top storage compartment lock, located on vehicle right side:
Place open-end wrench on bolt between roll bar and storage compartment cover. Turn wrench (1) towards rear of vehicle.

Open storage compartment cover and place in upright position (2).

Raising soft top manually

254

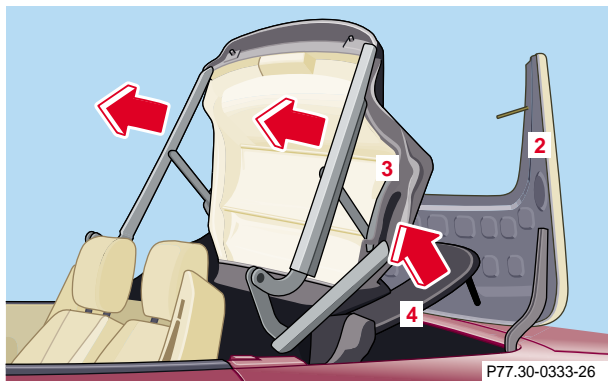

5. Pull soft top (3) out of compartment and place it in its vertical position.
6. Pull soft top bow (4) out of compartment.

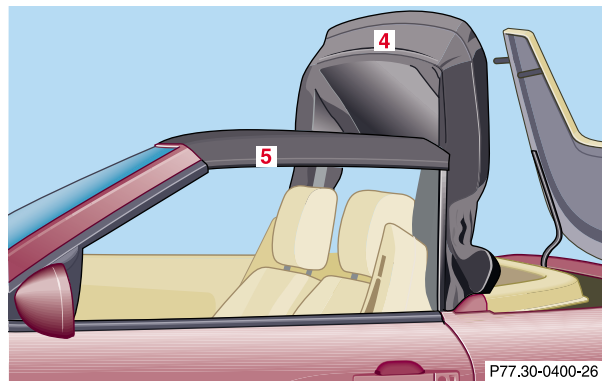

7. Place soft top frame (5) onto windshield header.
8. Place soft top bow (4) in its vertical position.

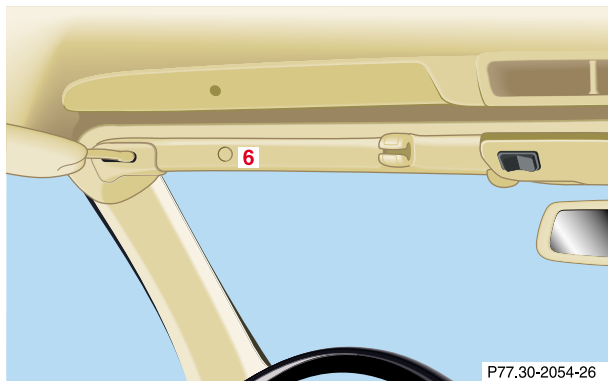

9. Pivot sun visors to side. Remove left and right caps (6).

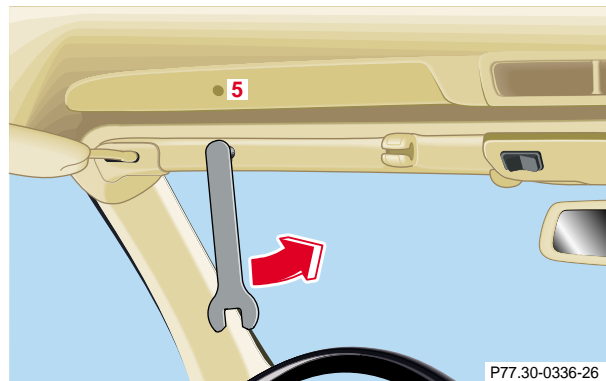

10. Using Allen-head wrench, lock left and right of soft top frame (5) to windshield header - turn wrench in 3 stages towards center of vehicle:
1. Left lock to first notch.
 2. Right lock to second notch.
 3. Left lock to second notch.

Raising soft top manually

256

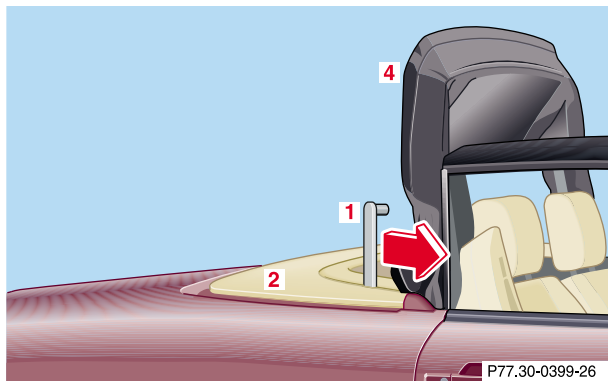

11. Close storage compartment cover (2). - Lock storage compartment lock on right side: Place open-end wrench on bolt between roll bar and storage compartment cover. Turn wrench (1) towards front of vehicle.
12. Lower soft top bow (4). The rear section of the soft top cannot be locked during manual operation.

Replacing wiper blade insert

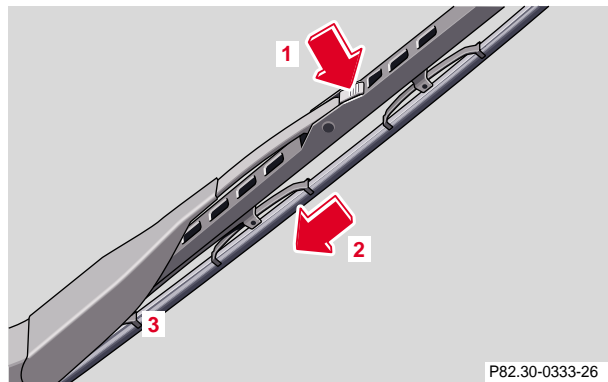

Windshield wiper blade

Removal:

Fold wiper arm forward. Press safety tab down (1), push wiper blade downward (2) and remove.

Installation:

Press down safety tab of new wiper blade. Insert wiper blade between the tabs (3) on the wiper arm. Then press safety tab upward until it locks in place.

Notes:

Do not open engine hood with wiper arm folded forward.

Do not allow the wiper arm to contact the windshield glass without a wiper blade inserted. The glass may be scratched or broken.

Make certain that the wiper blade is properly installed. An improperly installed wiper blade may cause windshield damage.

Replacing wiper blade insert

258

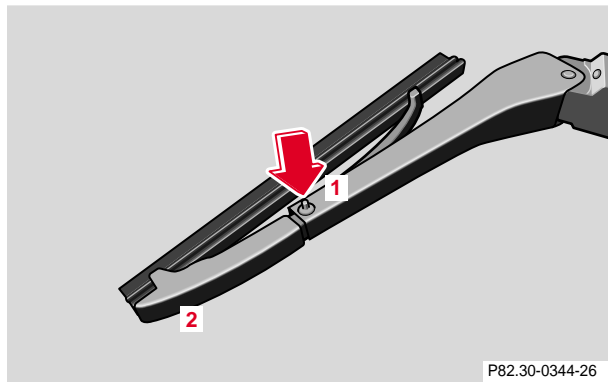
Headlamp wiper blades
(Halogen lamps)

Removal:

Fold wiper arm forward. Pull out pin (1) and remove wiper blade (2).

Installation:

Insert wiper blade and install pin.

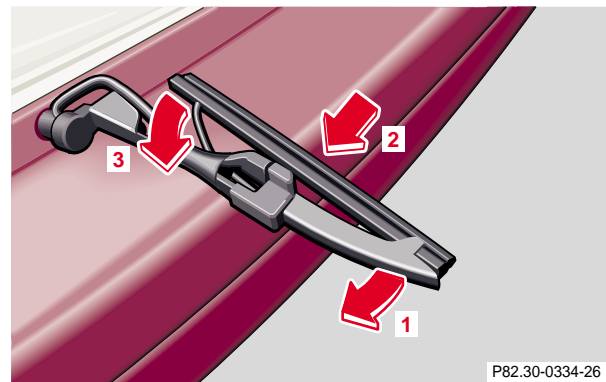
Headlamp wiper blades
(Xenon lamps)

Removal:

Fold wiper arm forward. Rotate wiper blade (2) in direction of arrow (1) until it releases from the wiper arm.

Installation:

Insert wiper blade (2) onto arm, perpendicular to arm, and rotate in direction of arrow (3) until it engages.

Manual release of fuel filler flap

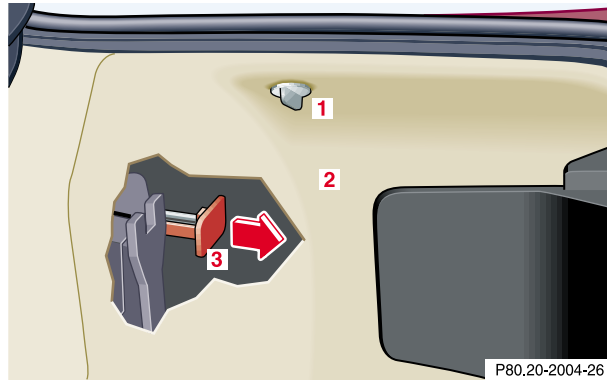

The manual release knob is located behind cover (2) in the right slide trunk panel.

In case the central locking system does not release the fuel filler flap:

1. Unscrew wing nut (1)
2. Pull panel (2) away from trunk wall.
3. Pull the manual release knob (3) (arrow) while simultaneously opening the fuel filler flap.

Trunk lamp

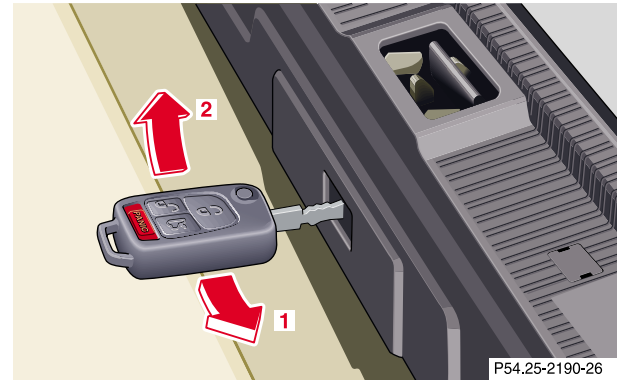

- 1 Switching off
- 2 Switching on

Switch off trunk lamp if the trunk is to remain open for a long period of time. This prevents the vehicle battery from being discharged.

When the trunk lid is closed, the switch will reset and turn on the lamp the next time the lid is opened.

Contents – Vehicle care

260

Vehicle care

Cleaning and care

of the vehicle 261

Power washer262

Tar stains262

Paintwork, Painted Body

Components262

Engine cleaning263

Vehicle washing263

Ornamental moldings 263

Headlamps, taillamps,
turn signal lenses 263

Window cleaning 264

Light alloy wheels 264

Instrument cluster 264

Steering wheel and
gear selector lever 264

Cup holder 264

Seat belts 265

Headliner, shelf behind
roll bars, and other hard
plastic trim items 265

Soft top265

Headliner266

Wind screen266

Automatic antenna266

Wiper blade266

Headlamp cleaning system266

Leather upholstery267

Plastic and rubber parts267

Illuminated door sill panels267

Cleaning and care of the vehicle

Warning!

Many cleaning products can be hazardous. Some are poisonous, others are flammable. Always follow the instructions on the particular container. Always open your car's doors or windows when cleaning the inside.

Never use fluids or solvents that are not designed for cleaning your car.

In operation, your vehicle is subjected to varying external influences which, if gone unchecked, can attack the paintwork as well as the underbody and cause lasting damage.

Such damage is caused not only by extreme and varying climatic conditions, but also by air pollution, road salt, tar, gravel and stone chipping. Grease and oil, fuel, coolant, brake fluid, bird droppings, insects, tree resins etc. should be removed immediately to avoid paint damage. Frequent washing reduces and/or eliminates the aggressiveness and potency of the above adverse influences.

More frequent washings are necessary to deal with unfavorable conditions; for example, near the ocean, in industrial areas (smoke, exhaust emissions), or during winter operation.

You should check your vehicle from time to time for stone chipping or other damage. Any damage should be repaired as soon as possible to prevent the start of corrosion.

In doing so, do not neglect the underside of the vehicle. A prerequisite for a thorough check is a washing of the underbody followed by a thorough inspection. Damaged areas need to be reundercoated.

Your vehicle has been treated at the factory with a wax-base rustproofing in the body cavities which will last for the lifetime of the vehicle. Post-production treatment is neither necessary nor recommended by Mercedes-Benz because of the possibility of incompatibility between materials used in the production process and others applied later.

We have selected car-care products and compiled recommendations which are specially matched to our vehicles and which always reflect the latest technology. You can obtain Mercedes-Benz approved car-care products at your authorized Mercedes-Benz Center.

Cleaning and care of the vehicle

262

Scratches, corrosive deposits, corrosion or damage due to negligent or incorrect care cannot always be removed or repaired with the car-care products recommended here. In such cases it is best to seek aid at your authorized Mercedes-Benz Center.

The following topics deal with the cleaning and care of your vehicle and give important “how-to” information as well as references to Mercedes-Benz approved car-care products.

Additional information can be found in the booklet titled “Vehicle Care Guide”.

Power washer

When using a power washer for cleaning the vehicle always observe manufacturers’ operating instructions.

Caution!

Never use a round nozzle to power wash tires. The intense jet of water can result in damage to the tire.

Always replace a damaged tire.

Always keep the jet of water moving across the surface. Do not aim directly at soft top, electrical parts, electrical connectors, seals, or other rubber parts.

Tar stains

Quickly remove tar stains before they dry and become more difficult to remove. A tar remover is recommended.

Paintwork, painted body components

Mercedes-Benz approved Paint Care should be applied when water drops on the paint surface to not “bead up”; normally in 3 to 5 months, depending on climate and washing detergent used.

Mercedes-Benz approved Paint Cleaner should be applied if paint surface shows signs of dirt embedding (i.e. loss of gloss).

Do not apply any of these products or wax if your car is parked in the sun or if the hood is still hot.

Use the appropriate MB-Touch-Up Stick for quick and provisional repairs of minor paint damage (i.e. chips from stones, car doors, etc.).

Engine cleaning

Prior to cleaning the engine compartment make sure to protect electrical components and connectors from the intrusion of water and cleaning agents.

Corrosion protection, such as MB Anticorrosion Wax should be applied to the engine compartment after every engine cleaning. Before applying, all control linkage bushings and joints should be lubricated. The poly-V-belt and all pulleys should be protected from any wax.

Vehicle washing

Do not use hot water or wash your vehicle in direct sunlight. Use only a mild car wash detergent, such as Mercedes-Benz approved Car Shampoo.

Thoroughly spray the vehicle with a diffused jet of water. Direct only a very weak spray towards the ventilation intake. Use plenty of water and rinse the sponge and chamois frequently.

Rinse with clear water and thoroughly wipe dry with a chamois. Do not allow cleaning agents to dry on the finish.

If the vehicle has been run through an automatic car wash – in particular one of the older installations – rewipe the recessed sections in the taillamps (designed to prevent soiling) if necessary. No solvents (fuels, thinners etc.) must be used.

In the winter thoroughly remove all traces of road salt as soon as possible.

When washing the underbody, do not forget to clean the inner sides of the wheels.

Ornamental moldings

For regular cleaning and care of very dirty chrome-plated parts, use a chrome cleaner.

Headlamps, taillamps, turn signal lenses

Use a mild car wash detergent such as Mercedes-Benz approved Car Shampoo, with plenty of water.

To prevent scratches, never apply strong force and use only a soft, non-scratchy cloth when cleaning the lenses. Do not attempt to wipe dirty lenses with a dry cloth or sponge.

Cleaning and care of the vehicle

264

Window cleaning

Use a window cleaning solution on all glass surfaces. An automotive glass cleaner is recommended.

Note:

For safety reasons, switch off wiper and remove key from steering lock before cleaning the windshield, otherwise the wiper motor can suddenly turn on and cause injury.

Light alloy wheels

Mercedes-Benz approved Wheel Care should be used for regular cleaning of the light alloy wheels.

If possible, clean wheels once a week with Mercedes-Benz approved Wheel Care, using a soft bristle brush and a strong spray of water.

Follow instructions on container.

Note:

Use only acid-free cleaning materials. The acid could lead to corrosion.

Instrument cluster

Use a gentle dishwashing detergent or mild detergent for delicate fabrics as a washing solution. Wipe with a cloth moistened in lukewarm solution. Do not use scouring agents.

Steering wheel and gear selector lever

Wipe with a damp cloth and dry thoroughly or clean with Mercedes-Benz approved Leather Care.

Cup holder

Use a gentle dishwashing detergent or mild detergent for delicate fabrics as a washing solution. Wipe with a cloth moistened in lukewarm solution. Do not use scouring agents.

Note:

For ease of cleaning, the cup holder between the front seats can be removed by pulling it up when in its closed position.

Seat belts

The webbing must not be treated with chemical cleaning agents. Use only clear, lukewarm water and soap. Do not dry the webbing at temperatures above 176 F (80 C) or in direct sunlight.

Warning!

Do not bleach or dye seat belts as this may severely weaken them. In a crash they may not be able to provide adequate protection.

Headliner, shelf behind roll bars, and other hard plastic trim items

Pour Mercedes-Benz approved Interior Care onto soft lint-free cloth and apply with light pressure.

Soft top

Clean soft top with soft top raised and locked. Lower the soft top into the storage compartment only if the top is completely dry. If the top is kept in the storage compartment for a lengthy period, raise it and air it out with the windows down about every 4 months.

Dry cleaning:

Brush top (always from front to rear) with a soft-bristled brush.

Wet cleaning:

Brush the dry top. Wash with a mild detergent and an ample supply of lukewarm water by wiping with a soft-bristled brush or sponge from front to rear. Then rinse thoroughly with clear water.

If only parts of the top have been washed, wet the entire top and allow it to air-dry before lowering it into the storage compartment.

Wipe the rear window with a cloth soaked with a mild, non-abrasive detergent, rinse and rub dry.

Do not use sharp-edged instruments for the removal of ice and snow.

Notes:

Never run the vehicle through an automatic car wash with the soft top in place or use a power washer to clean it, as you may damage the soft top material.

Remove bird droppings immediately. The organic acid damages the material and causes the soft top to leak.

Cleaning and care of the vehicle

266

In general, regular spraying or cleansing with clear water is sufficient to keep the top clean.

Wash the top only when heavily soiled.

Light colored soft tops should be cleaned frequently to prevent spots and dirt from setting in, which could stain and discolor the soft top material permanently.

Caution!

Never use any gasoline, thinner, tar and stain removers, glass cleaner, or similar organic solvents to clean the soft top, plastic window or wind screen. They will cause damage which is not covered by the Mercedes-Benz Limited Warranty.

Headliner

Soft top:

Clean with soft bristle brush, or use a dry-shampoo cleaner in case of excessive dirt.

Wind screen

Use only water or mild detergent to clean the wind screen.

Automatic antenna

For trouble-free operation of the automatic antenna, we recommend that you clean the antenna mast periodically.

Wiper blade

Clean the wiper blade rubber with a clean cloth and detergent solution.

Note:

For safety reasons, remove key from steering lock before cleaning the wiper blade, otherwise the wiper motor can suddenly turn on and cause injury.

Headlamp cleaning system

The condition of the wiper blades is important for satisfactory cleaning of the headlamp lenses. We therefore recommend that the blades be inspected regularly.

Leather upholstery

Using aftermarket seat covers or wearing clothing that have the tendency to give off coloring (e.g. when wet etc.) may cause the upholstery to become permanently discolored. By lining the seats with a proper intermediate cover, contact-discoloration will be prevented.

Wipe leather upholstery with a damp cloth and dry thoroughly or clean with Mercedes-Benz approved Leather Care. Exercise particular care when cleaning perforated leather as its underside should not become wet.

Plastic and rubber parts

Do not use oil or wax on these parts.

Illuminated door sill panels

Use a gentle dish-washing detergent or mild detergent for delicate fabrics as a washing solution. Wipe with a cloth moistened in lukewarm solution. Do not use scouring agents.

Contents – Technical data

268

Technical data

Spare parts service	269
Warranty coverage	269
Identification labels	270
Layout of poly-V-belt drive	271
Engine	272

Rims - Tires	273	Air conditioner refrigerant	278
Weights	275	Brake fluid	278
Main Dimensions	275	Premium unleaded gasoline	279
Fuels, coolants, lubricants etc. - capacities	276	Fuel requirements	279
Engine oils	278	Gasoline additives	280
Engine oil additives	278	Coolants	280
		Consumer information	282

Spare parts service

All authorized Mercedes-Benz Centers maintain a stock of original spare parts required for maintenance and repair work. In addition, strategically located parts distribution centers provide quick and reliable parts service.

More than 300 000 different spare parts, for Mercedes-Benz models, are available.

Mercedes-Benz original spare parts are subjected to stringent quality inspections. Each part has been specifically developed, manufactured or selected for and adapted to Mercedes-Benz vehicles.

Therefore, Mercedes-Benz original spare parts should be installed.

Important!

The use of non-genuine parts and accessories not authorized by Mercedes-Benz could damage the vehicle which damage is not covered by the Mercedes-Benz Limited Warranty or compromise its durability or safety.

Warranty coverage

Your vehicle is covered under the terms of the “warranties” printed in the Service and Warranty Information booklet and your authorized Mercedes-Benz Center will exchange or repair any defective parts originally installed on the vehicle in accordance with the terms of the following warranties:

1. New vehicle limited warranty
2. Emission systems warranty
3. Emission performance warranty
4. California, Massachusetts, and Vermont emission control systems warranty

Replacement parts and accessories are covered by the Mercedes-Benz Spare Parts and Accessories warranties, copies of which are available at any Mercedes-Benz Center.

Loss of Service and Warranty Information Booklet

Should you lose your Service and Warranty Information booklet, have your authorized Mercedes-Benz Center arrange for a replacement. It will be mailed to you.

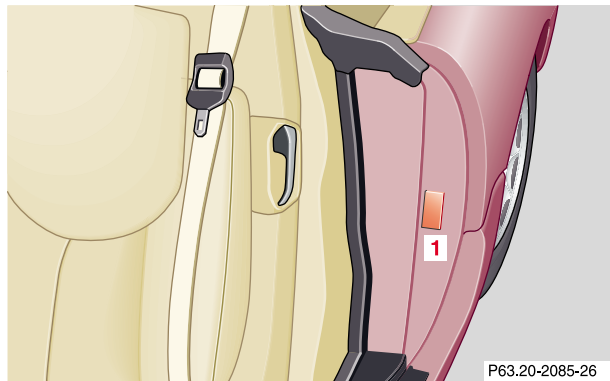
Identification labels

- 1** Certification label
(left door pillar)

Note:

When ordering spare parts, please specify vehicle identification and engine numbers.

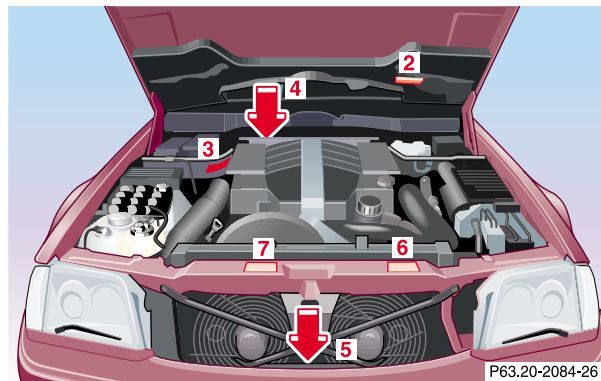

- 2** VIN, visible (lower edge of windshield)
- 3** Vehicle Identification No. (VIN)
- 4** Engine number
- 5** Body number and paintwork number
- 6** Emission control label
- 7** Information label
California version
Vacuum line routing for emission control system

Layout of poly-V-belt drive

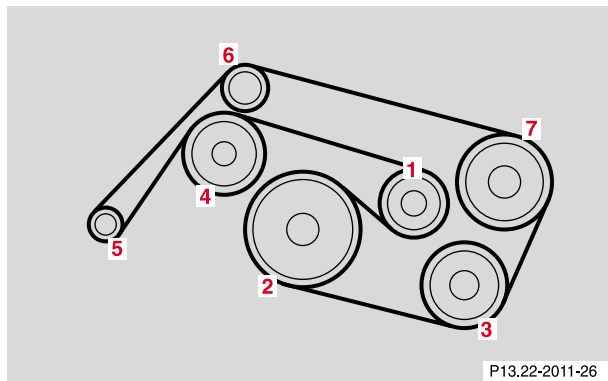

SL 500

- 1 Automatic belt tensioner
- 2 Crankshaft
- 3 Air conditioner compressor
- 4 SL 500: Coolant pump
SL 600: Fan

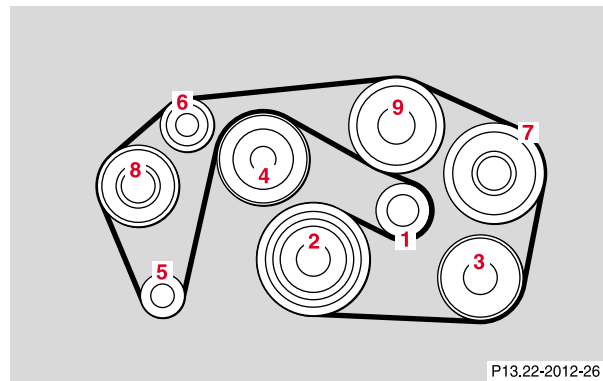

SL 600

- 5 Generator (alternator)
- 6 Idler pulley
- 7 Power steering pump
- 8 Air pump
- 9 Coolant pump

For dimensions of the poly-V-belts, see page 272.

Technical data

Model	SL 500 (129.068) ¹	SL 600 (129.076) ¹
Engine	113	120
Mode of operation	4-stroke engine, gasoline injection	4-stroke engine, gasoline injection
No. of cylinders	8	12
Bore	3.82 in (97.00 mm)	3.50 in (89.00 mm)
Stroke	3.30 in (84.00 mm)	3.16 in (80.20 mm)
Total piston displacement	303 cu.in. (4966 cm ³)	365.4 cu.in. (5987 cm ³)
Compression ratio	8.8:1	10:1
Output acc. to SAE J 1349	302 hp/5600 rpm (225 kW/5600 rpm)	389 hp/5200 rpm (290 kW/5200 rpm)
Maximum torque acc. to SAE J 1349	339ft.lb/2750 rpm (460 Nm/2750 rpm)	420ft.lb/3800 rpm (570 Nm/3800 rpm)
Maximum engine speed	6000 rpm	6000 rpm
Firing order	1-5-4-2-6-3-7-8	1-12-5-8-3-10-6-7-2-11-4-9
Poly-V-belts length	2390 mm	2585 mm

¹ The quoted data apply only to the standard vehicle. See an authorized Mercedes-Benz Center for the corresponding data of all special bodies and special equipment.

Rims – Tires

Rims and summer tires (except Sport Package)

Rims (light alloy)	8 ¹ / ₄ J x 17 H 2
Wheel offset:	1.33 in (34 mm)
All season tires: Radial-ply tires	245/45 R17 95 W
Winter tires: Radial-ply tires	245/45 R 17 45 H M+S ²

Spare wheel

Rim (light alloy)	8 ¹ / ₄ J x 17 H 2
Wheel offset:	1.33 in (34 mm)
All season tires: Radial-ply tires	245/45 R 17 95 W ²

2 Must only be used with special MB authorized snow chains.

Technical data

274

**Rims and summer tires
(Sport package)****Model****SL 500****SL 600**

Rims front axle

AMG light alloy rims

8 $\frac{1}{2}$ J x 18 H 28 $\frac{1}{2}$ J x 18 H 2

Wheel offset:

1.0 in (25 mm)

1.0 in (25 mm)

Rims rear axle

AMG light alloy rims

9 $\frac{1}{2}$ J x 18 H 2

10 J x 18 H 2

Wheel offset:

0.9 in (23 mm)

1.0 in (25 mm)

Radial-ply tires

front axle

245/40 ZR 18

245/40 ZR 18

rear axle

275/35 ZR 18³275/35 ZR 18³**Spare wheel**

Rim (light alloy)

8 $\frac{1}{4}$ J x 17 H 28 $\frac{1}{4}$ J x 17 H 2

Wheel offset:

1.33 in (34 mm)

1.33 in (34 mm)

All season tire:

Radial-ply tire

245/45 R 17 95W²245/45 R 17 95W²

2 Must only be used with special MB authorized snow chains.

3 Must not be used with snow chains.

Electrical system

Generator (alternator)	14 V/150 A
Battery	12V/100 Ah
Starter motor	
SL 500:	12V/1.7 kW
SL 600:	12V/2.2 kW
Spark plugs	
SL 500:	Bosch F 8 DPER Beru 14 FGH 8 DPUR X 2
SL 600:	Beru 14 FGH 8 DPUR X 2
Electrode gap	0.039 in (1.0 mm)
Tightening torque	15 – 22 ft.lb (20 – 30 Nm)

Weights

(see certification tag)

Hardtop load max.	66 lb (30 kg)
Trunk load max.	220 lb (100 kg)

Main dimensions

Overall vehicle length	177.1 in (4499 mm)
Overall vehicle width	71.3 in (1812 mm)
Overall height	51.3 in (1303 mm)
Wheel base	99.0 in (2515 mm)
Track, front	60.4 in (1535 mm)
Track, rear	60.0 in (1523 mm)

Fuels, coolants, lubricants etc. - capacities

276

Fuels, coolants, lubricants etc. - capacities

Vehicle components and their respective lubricants must match. Therefore use only brands tested and recommended by us. Please refer to the Factory Approved Service Products pamphlet, or inquire at your Mercedes-Benz Center.

	Model	Capacity	Fuels, coolants, lubricants etc.
Engine with oil filter	SL 500 SL 600	8.5 US qt (8.0 l) 10.6 US qt (10.0 l)	Recommended engine oils
Automatic transmission		9.6 US qt (9.1 l)	Automatic transmission fluid
Rear axle		1.5 US qt (1.4 l)	Hypoid gear oil SAE 90, 85 W 90
Hydraulic system for adaptive damping system (ADS)		approx. 4.8 US qt (4.5 l)	MB Hydraulic fluid
Power steering		approx. 1.1 US qt (1.0 l)	MB Power steering fluid
Front wheel hubs		approx. 2.1 oz (60 g) each	High temperature roller bearing grease
Accelerator control linkage			Hydraulic fluid
Brake system		approx. 0.5 US qt (0.5 l)	MB Brake fluid (DOT 4)

	Model	Capacity	Fuels, coolants, lubricants etc.
Windshield washer and/headlamp cleaning system		Vehicles without ADS: approx. 5.3 US qt (5.0 l) Vehicles with ADS: approx. 3.2 US qt (3.0 l)	MB Windshield washer concentrate "S" ¹
Cooling system	SL 500 SL 600	approx. 13.2 US qt (12.5 l) approx. 21.1 US qt (20.0 l)	MB Anticorrosion/antifreeze
Fuel tank including a reserve of		approx. 21.1 US gal (80.0 l) approx. 2.6 US gal (10.0 l)	Premium unleaded gasoline: Posted octane 91 (Avg. of 96 RON/86 MON)
Air conditioner system			R-134a refrigerant and special PAC lubricant <i>(Never R-12)</i>

1 Use MB Windshield Washer Concentrate "S" and water for temperatures above freezing or MB Windshield Washer Concentrate "S" and commercially available premixed windshield washer solvent/antifreeze for temperatures below freezing. Follow suggested mixing ratios, see page 225.

Engine oils

Engine oils are specifically tested for their suitability in our engines. Therefore, use only engine oils recommended by Mercedes-Benz. Information on recommended brands is available at your authorized Mercedes-Benz Center.

Please follow Service Booklet recommendations for scheduled oil changes. Failure to do so could result in engine damage not covered by the Mercedes-Benz Limited Warranty.

Engine oil additives

Do not blend oil additives with engine oil. They may be harmful to the engine operation.

Damage or malfunctions resulting from blending oil additives are not covered by the Mercedes-Benz Limited Warranty.

Air conditioner refrigerant

R-134a (HFC) refrigerant and special PAG lubricating oil is used in the air conditioner system.

Never use R-12 (CFC) or mineral-based lubricating oil, otherwise damage to the system will occur.

Brake fluid

During vehicle operation, the boiling point of the brake fluid is continuously reduced through the absorption of moisture from the atmosphere. Under extremely hard operating conditions, this moisture content can lead to the formation of bubbles in the system thus reducing the system's efficiency.

The brake fluid must therefore be replaced every two years, preferably in the spring.

It is recommended to use only brake fluid approved by Mercedes-Benz. Your authorized Mercedes-Benz Center will provide you with additional information.

Premium unleaded gasoline

Caution!

To maintain the engine's durability and performance, premium unleaded gasoline must be used. If premium unleaded is not available and low octane fuel is used, follow these precautions:

- have the fuel tank filled only partially with unleaded regular and fill up with premium unleaded as soon as possible,
- avoid full throttle driving and abrupt acceleration,
- do not exceed an engine speed of 3000 rpm, if the vehicle is loaded with a light load such as two persons and no luggage,
- do not exceed $\frac{2}{3}$ of maximum accelerator pedal position, if the vehicle is fully loaded or operating in mountainous terrain.

Fuel requirements

Use only Premium unleaded meeting ASTM standard D 439:

The octane number (posted at the pump) must be 91 min. It is an average of both the Research (R) octane number and the Motor (M) octane number: $[(R+M)/2]$. This is also known as ANTI-KNOCK INDEX.

Unleaded gasoline containing oxygenates such as Ethanol, IPA, IBA and TBA can be used provided the ratio of any one of these oxygenates to gasoline does not exceed 10%, MTBE not to exceed 15%.

The ratio of Methanol to gasoline must not exceed 3% plus additional cosolvents.

Using mixtures of Ethanol and Methanol is not allowed. Gasohol, which contains 10% Ethanol and 90% unleaded gasoline, can be used.

These blends must also meet all other fuel requirements such as resistance to spark knock, boiling range, vapor pressure etc.

Gasoline additives

A major concern among engine manufacturers is carbon build up caused by gasoline. Mercedes-Benz recommends the use of only quality gasoline containing additives that prevent the build up of carbon deposits.

After an extended period of using fuels without such additives, carbon deposits can build up especially on the intake valves and in the combustion area, leading to engine performance problems such as:

- warm-up hesitation,
- unstable idle,
- knocking/pinging,
- misfire,
- power loss.

Do not blend other specific fuel additives with fuel. They only result in unnecessary cost, and may be harmful to the engine operation.

Damage or malfunctions resulting from poor fuel quality or from blending specific fuel additives are not covered by the Mercedes-Benz Limited Warranty.

Coolants

The engine coolant is a mixture of water and anticorrosion/antifreeze, which provides:

- corrosion protection,
- freeze protection,
- boiling protection (by increasing the boiling point).

The cooling system was filled at the factory with a coolant providing freeze protection to approximately -22°F (-30°C) and corrosion protection.

If the antifreeze mixture is effective to -22°F (-30°C), the boiling point of the coolant in the pressurized cooling system is reached at approx. 266°F (130°C).

The coolant solution must be used year round to provide the necessary corrosion protection and increase in the boil-over protection. You should have it replaced every 3 years.

To provide the important corrosion protection, the solution must be at least 45% anticorrosion/antifreeze (equals a freeze protection to approx. - 22°F [-30°C]). If you use a solution that is more than 55% anticorrosion/antifreeze (freeze protection to approx. - 49°F [-45°C]),

the engine temperature will increase due to the lower heat transfer capability of the solution. Therefore, do not use more than this amount of anticorrosion/antifreeze.

If the coolant level is low, water and MB anticorrosion/antifreeze should be used to bring it up to the proper level (have cooling system checked for signs of leakage).

The water in the cooling system must meet minimum requirements, which are usually satisfied by normal drinking water. If you are not sure about the water quality, consult your authorized Mercedes-Benz Center.

Anticorrosion/antifreeze

Your vehicle contains a number of aluminum parts. The use of aluminum components in motor vehicle engines necessitates that anticorrosion/antifreeze coolant used in such engines be specifically formulated to protect the aluminum parts. (Failure to use such anticorrosion/antifreeze coolant will result in a significantly shortened service life).

Therefore the following product is strongly recommended for use in your car: Mercedes-Benz Anticorrosion/Antifreeze Agent.

Before the start of the winter season (or once a year in the hot southern regions), you should have the anticorrosion/antifreeze concentration checked. The coolant is also regularly checked each time you bring your vehicle to your authorized Mercedes-Benz Center for service.

Anticorrosion/antifreeze quantity

Model	Approx. freeze protection	
	-35°F (-37°C)	-49°F (-45°C)
SL 500	6.6 US qt (6.25 l)	7.3 US qt (6.9 l)
SL 600	10.6 US qt (10.0 l)	11.6 US qt (11.0 l)

Consumer information

This has been prepared as required of all manufactures of passenger cars under Title 49, Code of U.S. Federal Regulations, Part 575 pursuant to the “National Traffic and Motor Vehicle Safety Act of 1966”.

Uniform tire quality grading

Quality grades can be found where applicable on the tire sidewall between tread shoulder and maximum section width. For example:

Tread wear 200 Traction AA Temperature A

All passenger car tires must conform to federal safety requirements in addition to these grades.

Treadwear

The treadwear grade is a comparative rating based on the wear rate of the tire when tested under controlled conditions on a specified government test course. For example, a tire graded 150 would wear one and one-half (1 1/2) times as well on the government course as a tire graded 100. The relative performance of tires depends upon the actual conditions of their use, however, and

may depart significantly from the norm due to variations in driving habits, service practices and differences in road characteristics and climate.

Traction

The traction grades, from highest to lowest are AA, A, B, and C. Those grades represent the tire’s ability to stop on wet pavement as measured under controlled conditions on specified government test surfaces of asphalt and concrete. A tire marked C may have poor traction performance.

Warning!

The traction grade assigned to this tire is based on straightahead braking traction tests, and does not include acceleration, cornering, hydroplaning, or peak traction characteristics.

Temperature

The temperature grades are A (the highest), B, and C, representing the tire's resistance to the generation of heat and its ability to dissipate heat when tested under controlled conditions on a specified indoor laboratory test wheel. Sustained high temperature can cause the material of the tire to degenerate and reduce tire life, and excessive temperature can lead to sudden tire failure. The grade C corresponds to a level of performance which all passenger car tires must meet under the Federal Motor Vehicle Safety Standard No. 109. Grades B and A represent higher levels of performance on the laboratory test wheel than the minimum required by law.

Warning!

The temperature grade for this tire is established for a tire that is properly inflated and not overloaded. Excessive speed, underinflation, or excessive loading, either separately or in combination, can cause excessive heat build up and possible tire failure.

Index

A

ABS (Antilock brake system)	190
Malfunction indicator lamp	208
Adjusting steering column	
Storing steering column position in memory	70
ADS indicator lamp	212
ADS warning lamp	212
Air conditioner refrigerant	278
Airbags	60
Airbag OFF indicator lamp	213
SRS indicator lamp	206
Antenna	151
Antilock brake system (ABS)	190
Antitheft alarm system	42
Aquaplaning	180
Armrest	127
Ashtrays	130, 131
Audio system	
Anti-theft system	100
Button and soft key operation	101
Cassette mode	106
CD changer	110

CD mode	109
Operating and display elements	99
Operating safety	98
Operation	98, 102
Radio mode	104
Telephone operation	113
Automatic climate control	90
Air distribution	95
Air recirculation	96
Air volume	95
Basic setting - automatic mode	93
Defogging windows	94
Defrosting	94
Display and controls	92
Dust filter	97
Rear window defroster	95
Residual engine heat utilization	96
Automatic transmission	168
Emergency operation	174
Fluid level	221
Maneuvering	172
Program mode selector switch	173
Selector lever positions	169

B

BabySmart™ airbag deactivation system	58
Self-test	59
Backrest	48
BAS (Brake assist system)	188
Malfunction indicator lamp	207
Battery	236
Charge indicator lamp	211
Recycling	237
Brake assist system (BAS)	188
Brake fluid	278
Capacity	276
Brake pad wear indicator lamp	205
Brake warning lamp	204

C

Catalytic converter	163
Central locking system	30
Automatic central locking	38
Central locking switch	37
General notes	34
Locking and unlocking with remote control	31
Remote control	28, 30

Remote control – changing batteries	251
Vehicle keys	28
Changing wheels	230
Charge indicator lamp	211
Check engine malfunction indicator lamp	204
Check regularly and before a long trip	202
Checking engine oil level	221
Checking engine oil level indicator	82
Cleaning and care of the vehicle	261
Clock	79
Combination switch	86
Console storage compartments	127
Consumer information	282
Control and operation of radio transmitters	153
Coolant	
Adding coolant	224
Anticorrosion/antifreeze quantity	281
Checking level	223
Coolants	280
Low engine coolant level warning lamp	209
Temperature gauge	78
Cruise control	185
Cup holder	128, 264

D

Display illumination	77
Door control panel	20
Door pockets	129
Doors	35
Drinking and Driving	176
Drive sensibly - Save Fuel	176
Driving instructions	176
Block heater	183
Brakes	177
Deep water	184
Pedals	176
Traveling abroad	184
Winter driving	182
Driving off	178

E

Economy	93
Electronic stability program (ESP)	192
Emergency tensioning retractor (ETR)	60
Emergency unlocking in case of accident	38
Emission control	164
Engine compartment	219

Engine oil	
Additives	278
Capacities	276
Checking level	221
Consumption	83
Engine oils	278
Low level warning lamp	210
Engine oil level indicator	82
Engine oil temperature gauge	83
Entrance lamps in footwells, exit lamps in doors	120
ESP (Electronic Stability Program)	192
Control Switch	194
Malfunction indicator lamp	207
Synchronizing	193
Warning lamp	207
ETR (Emergency tensioning retractor)	60
SRS indicator lamp	206
Exterior lamp switch	84
Exterior lamps	242
Adjusting headlamp aim	247
Bulb for high and low beam	244
Failure indicator lamp	211
Headlamp assembly (Halogen)	243
Headlamp assembly (Xenon)	245
License plate lamps	250
Replacing bulbs	242

288

Taillamp assemblies	249
Turn signal, parking, side marker and standing lamp	244
F	
First aid kit	215
Flexible service system (FSS)	80
FSS indicator lamp	77
Fuel consumption gauge	83
Fuel filler flap, manual release	259
Fuel requirements	279
Fuel reserve and fuel cap placement warning	207
Fuel supply	200
Fuels, coolants, lubricants etc. - capacities	276
Fuses	218
G	
Garage door opener	133
Gasoline	
Additives	280
Fuel requirements	279
Premium unleaded	279

H

Hardtop	
Attaching hardtop	140
Removing	137
Hardtop or panorama roof	137
Hazard warning flasher switch	89
Head restraints	44
Headlamp assembly (Halogen)	243
Headlamp cleaning system	87
High beam indicator lamp	213
Hood	219

I

Identification labels	270
Illuminated vanity mirror	123
Indicator lamps in the instrument cluster	76, 204
Infant and Child Restraint Systems	
SRS indicator lamp	206
Infant and child restraint systems	67
Instrument cluster	74
Display illumination	77
Indicator lamps	76
Instrument lamps	77

Malfunction and indicator lamps	204
Instruments and controls	18
Interior	
General notes	124
Interior central locking system	125
Integration with vehicle central locking system	126
Separate locking of storage compartments	126
Interior lamps	120
Interior lighting	120

J

Jump starting	238
---------------------	-----

K

Keys	28
Flat key	29
Master key	28
Valet key	29

L

Layout of poly-V-belt drive	271
-----------------------------------	-----

Leather upholstery	267
Level control system	196
Lighter	131
Locking the vehicle	31

M

Maintenance	154
Malfunction lamps in the instrument cluster	204
Multicontour seats	49

N

Night security illumination	85
-----------------------------------	----

O

Odometer display field	82
On-board diagnostic system	204
Opening the trunk	32
Outside temperature indicator	78

290

P

Panic button	33
Parcel net in passenger footwell	128
Parking	178
Parking brake	175
Brake warning lamp	204
Passenger airbag indicator lamp	213
Power assistance	177
Power sunshade	122
Power windows	116
Express opening	117
Opening with key	41
Problems with your vehicle	14
Product information	7

R

Radio, telephone and two-way radio	153
Rain sensor	87
Raising soft top manually	253
Reading lamps	120
Rear storage compartment	129
Rear view mirrors	71
Exterior	72

Inside	71
Remote control	28
Changing batteries	251
Synchronizing	252
Replacement keys	
Obtaining	29
Replacing wiper blade insert	257
Roll bar	118
Roll bar warning lamp	212

S

Safety guidelines for the seat belt, emergency	
tensioning retractor and airbag	66
Seat belt nonusage warning system	53
Seat belts	52
Fastening	54
Unfastening	56
Warning lamp	206
Seat belts and integrated restraint system	52
Seats	44
Seat heater	50
Snow chains	181
Soft top	143
Lowering	144

Raising	145	Technical data	272
Spare parts service	269	Electrical system	275
Spare wheel	228	Main dimensions	275
SRS (Supplemental restraint system)	59	Rims – Tires	273
Indicator lamp	206	Weights	275
Start lock-out	34	Tele Aid	155
Malfunction lamp	77	Information	159
Starting and turning off the engine	167	Initiating an emergency call	157
Steering column		Roadside Assistance	158
Adjusting	70	Telephone, general	132
Steering lock	165	Telephones and two-way radio	153
Storage compartment (eyeglasses compartment)		The first 1 000 miles (1 500 km)	154
in the dashboard	124	Tires	
Stowing things in the vehicle	215	Driving instructions	179
Sun visors	123	Inflation pressure	234
Sunshade, electrical	122	Replacement	226
Sunshade, manual	121	Speed rating	181
Supplemental restraint system (SRS)	59	Traction	180
Synchronizing power windows	117	Tow-away alarm	43
		Tow-away protection	43
T		Towing the vehicle	240
Tachometer	79	Trip odometer	79
Taillamp assemblies	249	Trunk	39
Technical	272	Trunk lamp	259
		Trunk lid release switch	40

292

U

Unlocking the vehicle 31

V

Vehicle jack 217

Vehicle tools 216

W

Warranty coverage 269

What you should know at the gas station 200

Wheels 226

Changing 230

Rotating 227

Spare wheel 228

Tire replacement 226

Where to find it 13

Wind screen 148

Installation 148

Removal 150

Setting up 150

Windshield and headlamp washer system

Check level 202

Fluid mixing ratio 225

Low fluid level warning lamp 210

Windshield washer fluid mixing ratio 88

Wiper blade, replacing insert 257

Service and Literature

Your authorized Mercedes-Benz Center has trained technicians and original Mercedes-Benz parts to service your vehicle properly. For expert advice and quality service, see your authorized Mercedes-Benz Center.

If you are interested in obtaining service literature for your vehicle, please contact your authorized Mercedes-Benz Center. We consider this the best way for you to obtain accurate information for your vehicle.

For further information you can find us on the Mercedes-Benz web-site
www.mbusa.com

Warning!

To help avoid personal injury, be extremely careful when performing any service work or repairs. Improper or incomplete service or the use of incorrect or inappropriate parts or materials may damage the vehicle or its equipment, which may in turn result in personal injury.

If you have any question about carrying out some service, turn to the advice of an authorized Mercedes-Benz Center.

We reserve the right to modify the technical details of the vehicle as given in the data and illustrations of this Operator's Manual. Reprinting, translation and copying, even of excerpts, is not permitted without our prior authorization in writing.

Title illustration no. P00.00-2645-26

Press time 03/31/00
MBUSA/TI
Printed in the U.S.A.